

INSPIRED INNOVATION

Despatch
INDUSTRIES

RFD OVEN SERIES WITH PROTOCOL 3™ CONTROLLER OWNER'S MANUAL

C-250
PN 320253
VERSION 1
11/2012

SERVICE AND TECHNICAL SUPPORT

service parts: 1-800-473-7373

international service/main: 1-952-469-8230

service fax: 1-952-469-8193

service@despatch.com

GLOBAL HEADQUARTERS

phone: 1-952-469-5424

toll free usa: 1-888-337-7282

fax: 1-952-469-4513

sales@despatch.com

service@despatch.com

8860 207th Street West
Minneapolis, MN 55044 USA

Despatch
INDUSTRIES

Revision History

Revision	Date	Author	Description
1	11/2012	Livingston	Format changes and revised for Protocol 3.

Copyright © 2012 by Despatch Industries.

All rights reserved. No part of the contents of this manual may be reproduced, copied or transmitted in any form or by any means including graphic, electronic, or mechanical methods or photocopying, recording, or information storage and retrieval systems without the written permission of Despatch Industries, unless for purchaser's personal use.

Table of Contents

1.	About This Manual.....	6
1.1.	Important User Information.....	6
1.2.	Manufacturer & Service	7
1.3.	Organization of this Manual	7
1.4.	Conventions.....	8
1.5.	Specifications	8
1.5.1.	Dimensions	8
1.5.2.	Capacities	9
1.5.3.	Temperatures	10
1.5.4.	Power.....	11
1.5.5.	Capability	12
2.	Safety.....	13
2.1.	Safety Information.....	13
2.1.1.	Lockout.....	13
2.1.1.1.	Lockout Requirements.....	13
2.1.1.2.	Lockout Procedure.....	13
2.2.	Maintenance	14
2.3.	Electrical Power.....	14
2.4.	Fire.....	14
2.5.	Equipment Lockout Requirements	14
2.5.1.	Optional Disconnect Switch	15
3.	Theory of Operation	16
3.1.	The RFD Oven Series.....	16
3.2.	Damper Control	17
3.2.1.	Determining Damper Settings	18
3.2.1.1.	Fresh Air Damper Fully Closed Position	18
3.2.1.2.	Fresh Air Damper Fully Open Position	18
3.2.1.3.	Exhaust Damper Control	18
3.3.	Optional Adjustable Louvers.....	19
3.3.1.	Purpose of Adjustable Airflow	20
3.3.2.	Supply Air Adjustment.....	20
3.3.3.	Return Air Adjustment	20
3.4.	The Protocol 3 Controller.....	20
3.5.	Optional High Limit Audible Alarm	22
3.6.	Purge Timer	22
3.7.	Airflow Interlocking Safety Switch.....	22
4.	Assembly & Setup.....	23
4.1.	Unpack & Inspect The RFD Oven	23
4.1.1.	If Damaged During Shipping	23
4.2.	Set up The RFD Oven	23
4.2.1.	Select Oven Location	23
4.2.1.1.	Placement Requirements	24
4.3.	Exhaust Connections	24
4.4.	Wiring & Power Connections	25
5.	Operation.....	26
5.1.	Load Oven	26
5.2.	Pre-Startup Checklist.....	27
5.3.	Operating Procedure.....	28

5.3.1. Check Fan Rotation and Other Preliminaries	28
5.3.2. Start and Operate the Oven.....	29
5.3.3. Shutdown.....	29
5.3.4. Working with Protocol 3 Operating Modes	30
6. Maintenance	31
6.1. Checklist.....	31
6.2. Maintenance Schedule.....	32
6.3. Check Fans	33
6.4. Test Purge Timer	33
6.5. Test Airflow Switch	33
6.5.1. To Set or Adjust Airflow Switch.....	33
6.5.2. Example: Verify Exhaust Fan Airflow Switch Setpoint.....	33
6.6. Lubrication	35
6.7. Check Safety Controls.....	35
6.8. Check High-Limit Controller	35
6.9. Replacement Parts	36
6.10. Repairs.....	36
6.10.1. Protocol 3 Controller	36
7. Troubleshooting.....	37
7.1. Troubleshooting: Possible Problems and Solutions	37
7.2. Troubleshoot Airflow Conditions.....	38
7.3. Troubleshooting: Error Messages and Alarm.....	39
8. Appendices	40
8.1. Standard Products Warranty	40
8.2. MRC5000 Setup (Optional)	41
8.3. Electrical Schematics.....	41

Figures

Figure 1. Design Information and Specification Label.	10
Figure 2. Electrical Specification Label.	11
Figure 3. Disconnect Switch.....	15
Figure 4. RFD Oven Series.	16
Figure 5. RFD Fresh Air Damper Control.....	17
Figure 6. RFD Exhaust Damper Control.....	17
Figure 7. Standard perforated panels and adjustable louvers.	19
Figure 8. Initial factory settings for optional louvers.	19
Figure 9. Protocol 3 Operator Interface.....	21
Figure 10. The Purge timer red light is illuminated during the timing period.....	22
Figure 11. Airflow interlocking safety switch.....	22
Figure 12. RFD Forced Exhaust Assembly.	24
Figure 13. Power, Heat and Alarm Silence Switches.....	28
Figure 14. Minimum purge time is listed on the RFD oven design specification label.	28
Figure 15. Airflow Switch Indicator.	34
Figure 16. Adjust the airflow switch.	35
Figure 17. RFD2-13-2E, 208V (Drawing 320219-01).	42
Figure 18. RFD2-13-2E, 208V (Drawing 320219-02).	42
Figure 19. RFD2-13-2E, 240V (Drawing 320221-01).	42
Figure 20. RFD2-13-2E, 240V (Drawing 320221-02).	42

Figure 21. RFD2-13-2E, 480V (Drawing 320223-01).....	42
Figure 22. RFD2-13-2E, 480V (Drawing 320223-02).....	42
Figure 23. RFD2-13-2E Oven Assembly (Drawing 148457-01).....	42
Figure 24. RFD2-19-2E, 208V (Drawing 320228-01).....	42
Figure 25. RFD2-19-2E, 208V (Drawing 320228-02).....	42
Figure 26. RFD2-19-2E, 240V (Drawing 320230-01).....	42
Figure 27. RFD2-19-2E, 240V (Drawing 320230-02).....	42
Figure 28. RFD2-19-2E, 480V (Drawing 320232-01).....	42
Figure 29. RFD2-19-2E, 480V (Drawing 320232-02).....	42
Figure 30. RAD2-19-2E Oven Assembly (Drawing 162533-01).....	42
Figure 31. RFD2-35-2E, 208V (Drawing 320237-01).....	42
Figure 32. RFD2-35-2E, 208V (Drawing 320237-02).....	42
Figure 33. RFD2-35-2E, 240V (Drawing 320239-01).....	42
Figure 34. RFD2-35-2E, 240V (Drawing 320239-02).....	42
Figure 35. RFD2-35-2E, 480V (Drawing 320241-01).....	42
Figure 36. RFD2-35-2E, 480V (Drawing 320241-02).....	42
Figure 37. RFD2-35-2E Oven Assembly (Drawing 148439-01).....	42

Tables

Table 1. Damper Positions for Chamber Pressure.....	17
Table 2. Purge timer settings for various RFD models.....	22
Table 3. Troubleshooting grid.....	37
Table 4. Airflow Troubleshooting.....	38
Table 5. Error Messages and Next Steps.....	39
Table 6. MRC 5000 Settings.....	41

1. About This Manual

1.1. Important User Information



Copyright © 2012 by Despatch Industries.

All rights reserved. No part of the contents of this manual may be reproduced, copied, or transmitted in any form or by any means including graphic, electronic, or mechanical methods or photocopying, recording, or information storage and retrieval systems without the written permission of the publisher, unless it is for the purchaser's personal use.

Printed and bound in the United States of America.

The information in this manual is subject to change without notice and does not represent a commitment on the part of Despatch Industries. Despatch Industries does not assume any responsibility for any errors that may appear in this manual.

In no event will Despatch Industries be liable for technical or editorial omissions made herein, nor for direct, indirect, special, incidental, or consequential damages resulting from the use or defect of this manual.

	<p><i>Before operating this equipment, carefully read instruction manual.</i></p>
	<p><i>Values displayed on screens are examples only. Though those values may be typical, contact Despatch Industries for the final value.</i></p>
	<p><i>Users of this equipment must comply with operating procedures and training of operation personnel as required by the Occupational Safety and Health Act (OSHA) of 1970, Section 5 and relevant safety standards, as well as other safety rules and regulations of state and local governments. Refer to the relevant safety standards in OSHA and National Fire Protection Association (NFPA), section 86 of 1985.</i></p>

Copyright © 2012 by Despatch Industries.

All rights reserved. No part of the contents of this manual may be reproduced, copied or transmitted in any form or by any means including graphic, electronic, or mechanical methods or photocopying, recording, or information storage and retrieval systems without the written permission of Despatch Industries, unless for purchaser's personal use.

	<p><i>Danger!</i></p> <p><i>Only fully-trained and qualified personnel should setup and maintain this equipment. Improper setup and operation of this equipment could cause an explosion that may result in equipment damage, personal injury or possible death.</i></p>
---	--

The information in this document is not intended to cover all possible conditions and situations that might occur. The end user must exercise caution and common sense when installing or maintaining Despatch Industries products. If any questions or problems arise, call Despatch Industries at **1-888-DESPATCH** or **1-952-469-5424**.

1.2. **Manufacturer & Service**

The RFD oven series, which includes RFD2-13, RFD2-19 and RFD2-35, is manufactured by Despatch Industries.

Despatch has specialized in thermal processing for over 100 years. Technical expertise gained over those years helps provide innovative solutions to critical applications in vertical markets and cutting edge technology worldwide. Despatch products are backed by a drive for long-term customer satisfaction and a strong sense of responsibility. The worldwide network of factory-trained Service Professionals is available to support your Despatch equipment. From full service preventive maintenance to routine repair and certified calibration and uniformity, the Despatch service network is positioned to respond to your business needs. Our service programs are customized to meet your specific needs using our Advantage Service Assurance Program (ASAP). For more information on ASAP, visit www.despatch.com.



Global Headquarters	Contact	Service & Technical Support
Despatch Industries 8860 207th Street Lakeville, MN 55044 USA	International/Main: 1-952-469-5424 US toll free: 1-888-337-7282 Fax: 1-952-469-4513 info@despatch.com www.despatch.com	Service: 1-952-469-8230 US toll free: 1-800-473-7373 Service @despatch.com

1.3. **Organization of this Manual**

This owner's manual contains the most comprehensive set of information for the Despatch RFD oven series, including installation instructions, theory of operation, and operating instructions, among other things. To save time and expense in case of trouble, it is urged that the operators search this manual for helpful suggestions before requesting factory assistance.

	<p>Danger!</p> <p><i>Failure to heed warnings in this instruction manual and on the oven could result in personal injury, property damage or death.</i></p>
---	--

1.4. Conventions

	<p><i>This icon signifies information that describes an unsafe condition that may result in death, serious injury, or damage to the equipment.</i></p>
<p>Danger!</p>	<p><i>Danger is the signal word used to indicate a hazardous situation that, if not avoided, will result in death or severe injury.</i></p>
<p>Warning!</p>	<p><i>Warning is the signal word used to indicate a hazardous situation that, if not avoided, could result in death or severe injury.</i></p>
<p>Caution!</p>	<p><i>Caution is the signal word used to indicate a hazardous situation that, if not avoided, could result in moderate or minor injury.</i></p>
<p>Notice</p>	<p><i>Notice is the signal word used to indicate a hazardous situation that, if not avoided, could result in property damage.</i></p>
	<p><i>This icon signifies supplemental important information.</i></p>
<p>LOG OUT</p>	<p><i>Bold, 10 point sans-serif typeface indicates a specific key or button on screen to click.</i></p>

1.5. Specifications

1.5.1. Dimensions

Models	Chamber Size inches (cm)			Capacity ft ³ (liters)	Overall Size inches (cm)			Maximum Number of Shelves (3 in. centers)	Exhaust Outlet Diameter in (cm)
	W	D	H		W	D	H		
RFD2-13	24.5 (62)	25 (64)	37 (94)	13 (368)	67.5 (171)	42 (107)	91.5 (232)	12	7 (17.8)
RFD2-19	36.5 (93)	25 (64)	37 (94)	19.5 (552)	79.5 (203)	42 (107)	91.5 (232)	12	7 (17.8)
RFD2-35	47.5 (121)	30 (76)	42 (107)	35 (991)	92 (234)	47 (119)	96.5 (245)	14	7 (17.8)

Copyright © 2012 by Despatch Industries.

All rights reserved. No part of the contents of this manual may be reproduced, copied or transmitted in any form or by any means including graphic, electronic, or mechanical methods or photocopying, recording, or information storage and retrieval systems without the written permission of Despatch Industries, unless for purchaser's personal use.

1.5.2. Capacities

Capacity	Model RFD2-13	Model RFD2-19	Model RFD 2-35
Maximum load capacity (Lbs) (Kg)	850 386	850 386	1250 567
Maximum shelf capacity (Lbs) (Kg)	100 45.4	100 45.4	100 45.4
Exhaust capacity (min/max) (CFM) (Lps)	54/350 25.5/165.2	54/350 25.5/165.2	216/350 101.9/165.2
Recirculating fan (HP) (CFM) (Lps)	1 1150 543	1 1150 543	2 1550 731
Net weight (Approximate) (Lbs) (Kg)	1205 547	1495 678	1745 792
Shipping weight (Approximate) (Lbs) (Kg)	1405 637	1695 769	1945 882
Solvent Handling Capabilities M.E.K. or equivalent at 177°C (350°F) (GPH) (LPH)	.06 .23	.06 .23	.24 .91
Forced Exhaust (HP)	1/3	1/3	1/3

1.5.3. Temperatures

Feature	Range	Model RFD 2-13	Model RFD 2-19	Model RFD 2-35
Maximum Operating Temperature (°C) (°F)			343	
			650	
Time to Temperature (No Load)	40°C – 177°C	15	16	12
	40°C – 260°C	28	30	22
	40°C – 343°C	45	48	36
Temperature Uniformity at (°C) (°F)	177		+/-2	
	350		+/-4	
	260		+/-2.8	
	500		+/-6	
	343		+/-3.7	
	650		+/-7.5	
Minimum Operating Temperature Above Ambient* (°C) (°F)			8.3	
			15	
Control Stability (Δ represents the change in ambient temperature) (°C)			+/- 0.5/5 Δ	
Repeatability (°C)			+/- 0.5	

Refer to the Design Information and Specification labels on your oven for temperature specifics pertaining to your oven (Figure 1).

Figure 1.
Design
Information
and
Specification
Label.

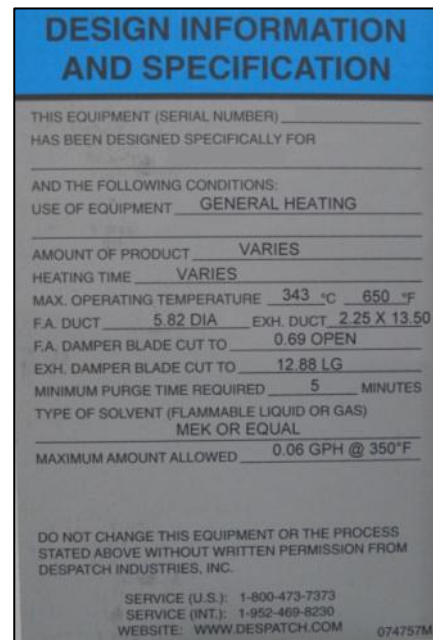

* Uniformity figures are based on a nine-point test conducted in an empty oven after stabilization period. Uniformity can vary slightly depending on unit and operating conditions. Minimum operating temperature and cooling times are based on 20°C ambient temperature measured at the fresh air inlet with the fresh air and exhaust dampers fully open. Specifications are subject to change without notice.

Copyright © 2012 by Despatch Industries.

All rights reserved. No part of the contents of this manual may be reproduced, copied or transmitted in any form or by any means including graphic, electronic, or mechanical methods or photocopying, recording, or information storage and retrieval systems without the written permission of Despatch Industries, unless for purchaser's personal use.

1.5.4. Power

Line voltages may vary in some geographies. If the line voltage for your RFD oven varies more than 10% from the oven voltage rating, electrical components such as relays and temperature controls may operate erratically.

- If the line voltage is lower than the oven voltage rating, heat-up time may be significantly longer and motors may overload or run hot
- If the line voltage is higher than the nameplate rating, motors may run hot and draw excessive amperage

Refer to the Electrical Specifications on your oven for the specifics pertaining to your oven (Figure 2).

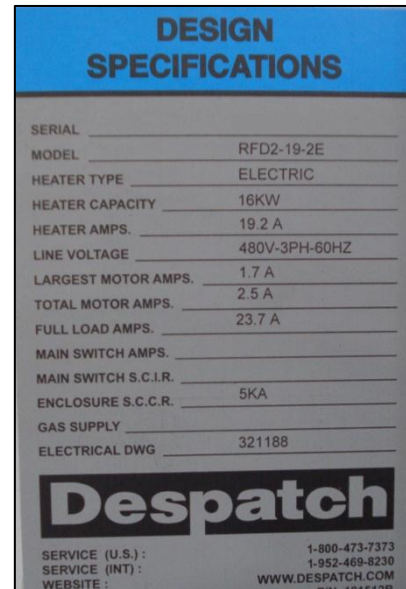

Figure 2. Electrical Specification Label.

Model	Volts [†]	Amps	Hertz [‡]	Electrical Phase	KW
RFD2-13	208	55.9	60	3	18
	240	44.5			16
	480	22.2			16
RFD2-19	208	55.9	60	3	18
	240	44.5			16
	480	22.2			16
RFD2-35	208	84	60	3	27
	240	86			32
	480	43			32

[†] An oven designed for 240 volts (see oven nameplate) will operate satisfactorily on a minimum of 208 Volts, but will result in 25% reduced heater output. If your power characteristic is lower, contact Despatch Industries.

[‡] 50 hertz electrical is available on all models.

1.5.5. Capability

The RFD oven is specifically designed for Class A NFPA 86 requirements, in which flammable solvents are present. They include a pressure relief panel, purge timer and exhaust fan. Please note the solvent handling capabilities and do not exceed.

	<p><i>Danger!</i></p> <p><i>Class A ovens are designed for a specific amount of solvent. Exceeding this amount could result in an explosion. Refer to Design Specification Label (Figure 14) or Section 1.5.2 for the solvent handling capabilities of this oven. Do not process closed containers of any substance or liquid in this oven because they may explode under heat. In case of fire, leave door(s) as they are. Shut off electricity. Shut off fuel. Call the fire department. Stay away.</i></p>
---	---

2. Safety

2.1. Safety Information

Do not work on the RFD oven without reading and understanding this section which contains important information and warnings. Ignoring these warnings can result in death, serious injury or damage to the machine and product.

2.1.1. Lockout

Machine lockout places the RFD oven into a zero energy state and prevents accidental machine start up. Always follow the Lockout Procedure described in this section before cleaning, maintaining or repairing the RFD oven.

	<p>Danger!</p> <p><i>Electrical panels contain high voltage. Disconnect and lock out the power supply before working inside any electrical panels. Failure to lock out the power supply can result in death or injury.</i></p>
---	---

	<p>Danger!</p> <p><i>An accidental start-up, while working on the RFD oven, can result in serious injury or death.</i></p>
--	---

2.1.1.1. Lockout Requirements

1. Every power source that can energize any element of the RFD oven must be shut off at the closest possible power source. This includes air, water, electricity, and the Disconnect Switch.
2. After energy sources are locked out, test to ensure circuits are de-energized.

2.1.1.2. Lockout Procedure

Personnel authorized to lockout equipment must have the necessary locks to perform the lockout.

1. Physically disconnect all electrical power to the machine or lockout the appropriate breaker or disconnects.
2. Close all valves and bleed off any pressure.
3. Test for power by attempting a start with the machine controls.
4. Identify the Lockout Condition with a tag on the electrical disconnect and pneumatic shut off valve.
5. When work is complete, remove all tags and restore the machine to its working state.

2.2. Maintenance

Only qualified and trained personnel should perform maintenance or repair.

2.3. Electrical Power

Only qualified and trained personnel should perform electrical maintenance or electrical repair.

	<p>Danger!</p> <p><i>High voltage present on this equipment, service by authorized personnel only. Contact with energized electrical sources may result in serious injury or death.</i></p>
---	--

- Before performing maintenance, disconnect all electrical power from the machine. Use a padlock and lockout all disconnects feeding power to the machine.
- Never clean or repair the oven when in operation.
- Unauthorized alterations or modifications to RFD oven are strictly forbidden. Never modify any electrical circuits. Unauthorized modifications can impair the function and safety of the RFD oven.

2.4. Fire

Keep the RFD oven clean and free of scrap materials, oil or solvents to prevent the possibility of fire. In the event of fire, follow these steps.

1. Leave door as is.
2. Shut off electricity.
3. De-energize the machine immediately by turning OFF the **DISCONNECT SWITCH**.
4. Turn off the remote main disconnect (customer supplied disconnect).
5. Shut off fuel.
6. Call the fire department.
7. Stay away.

	<p>Danger!</p> <p><i>Always disconnect all power before extinguishing a fire. Attempting to extinguish a fire in a machine connected to electrical power can result in serious injury or death.</i></p>
---	--

2.5. Equipment Lockout Requirements

To prevent injury or equipment damage during inspection or repair, the RFD oven must be locked out.

2.5.1. Optional Disconnect Switch

The RFD oven has an optional Disconnect Switch (Figure 3). This Disconnect Switch is connected to the load break switch behind the panel that disconnects or connects power from the main line. When a risk of personal injury or damage to the RFD oven exists, turn OFF the **DISCONNECT SWITCH** on the front of the oven. This shuts off all electrical power to the oven.



Figure 3. Disconnect Switch.

3. Theory of Operation

3.1. The RFD Oven Series

Despatch RFD ovens feature horizontal recirculating airflow to ensure exceptional temperature uniformity throughout the oven. A high-volume fan circulates air through perforated, stainless steel walls to create a constant horizontal airflow across all sections of the oven. The result is proven reliability in demanding production and laboratory applications, such as curing, drying, sterilizing, aging, and other process-critical applications.

The RFD ovens are for applications that include flammable solvents or large amounts of moisture removal. These Class A ovens are specially designed to meet NFPA 86 requirements. They include a pressure relief panel, purge timer and exhaust fan.



Figure 4. RFD Oven Series.

	<p>Danger!</p> <p><i>Class A ovens are designed for a specific amount of solvent. Exceeding this amount could result in an explosion. Refer to Design Specification Label (Figure 14) or Section 1.5.2 for the solvent handling capabilities of this oven. Do not process closed containers of any substance or liquid in this oven because they may explode under heat. In case of fire, leave door(s) as they are. Shut off electricity. Shut off fuel. Call the fire department. Stay away.</i></p>
---	---

<p>Notice</p>	<p><i>With the damper in full closed position, a predetermined amount of fresh air enters the chamber via cutaways in the fresh air and exhaust dampers. This amount of fresh air meets NFPA86 Safety Guidelines for Class A ovens.</i></p>
---------------	---

3.2. Damper Control

The RFD Series oven includes a manually adjustable fresh air damper mechanism which controls the flow of fresh air into the chamber. The fresh air damper control is located on the left side of the oven (Figure 5 and Figure 6). The oven also includes a manually adjustable exhaust damper located on the exhaust stack on top of the oven (Figure 6).

Fresh air and exhaust dampers (Figure 5) control the amount of air exchanged as well as the oven chamber pressure. The RFD exhaust damper and fresh air damper are designed to remain slightly open to allow gases released from processed solvents to escape. In “closed” position, the dampers are actually slightly open. When the fresh air damper is closed and the exhaust damper is open, oven chamber pressure tends toward negative. When the fresh air damper is open and the exhaust damper is closed, the oven chamber pressure tends toward positive (Table 1).

A negative oven pressure may draw ambient air into any opening, causing cool spots to occur. The slightly pressurized chamber produces the effect of pushing air to the corners of the chamber. However, too much positive pressure may force hot air or process vapors out of any openings in the oven into the work area. Ideally, the fresh air and exhaust dampers should be closed as much as possible and the oven should be maintained at a neutral or slightly positive pressure.

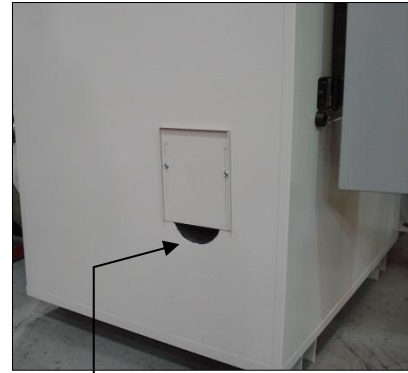

Fresh Air Damper Control

Figure 5. RFD Fresh Air Damper Control.

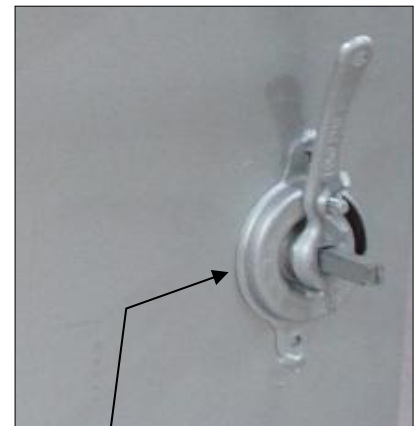

Exhaust Damper Control

Figure 6. RFD Exhaust Damper Control.

	<p>Warning!</p> <p><i>Maintain slight positive pressure to regulate heat.</i></p> <p><i>Too much positive pressure in an oven can create a high outer skin temperature as hot air is forced out through panel joints and around door seal. High outer skin temperature could warp the front of the oven.</i></p>
---	---

Table 1. Damper Positions for Chamber Pressure.

Damper	Position	
Fresh Air	Open	Closed
Exhaust	Closed	Open
Chamber Pressure	Positive	Negative

3.2.1. Determining Damper Settings

The optimum setting for the amount of fresh air that should be distributed into the chamber depends on several factors. These factors include ambient environment temperature, load conditions, load distribution, heat-up rates, cool-down rates, desired temperature uniformity and, most importantly, the desired operating temperature. Carefully consider existing engineering tradeoffs while using guidelines to determine the fresh air damper setting.

In general, the damper should be set so that the amount of fresh air flowing into the chamber agrees with the desired operating temperature conditions. The following paragraphs show the considerations involved with various damper position settings.

3.2.1.1. Fresh Air Damper Fully Closed Position

The chamber achieves maximum attainable heat-up rates when the fresh air damper lies in the full closed position. With the damper in the full closed position, the chamber will operate at the desired temperature using the minimum amount of power. In most cases, the oven also efficiently operates at the chamber's maximum operating temperature when in the full closed position.

3.2.1.2. Fresh Air Damper Fully Open Position

The chamber operates at its minimum operating temperature with the fresh air damper in full open position.

Friction heat from the air recirculation system builds up in the chamber. This causes chamber temperature to rise slightly even without the heating system on. The chamber reaches thermal equilibrium temperature after the recirculation motor runs for an extended period of time.

The chamber cannot readily dissipate heat generated by friction without a fully open fresh air damper. With the fresh air damper fully open, the thermal equilibrium temperature is the minimum operating temperature of the chamber.



When the damper is in full open position, the oven may not be able to heat to the maximum oven operating temperature.

3.2.1.3. Exhaust Damper Control

Adjusting the exhaust damper (Figure 6) aids in pressurizing the chamber.

3.3. Optional Adjustable Louvers



This section applies only to ovens that include the optional adjustable louvers. Ovens without the louver option do not have adjustable airflow.

RFD oven series come standard with perforated supply and exhaust panels (Figure 7). Optional adjustable louvers provide an extra measure of airflow customization (Figure 7). Figure 7 shows the initial factory settings for the optional louvers.

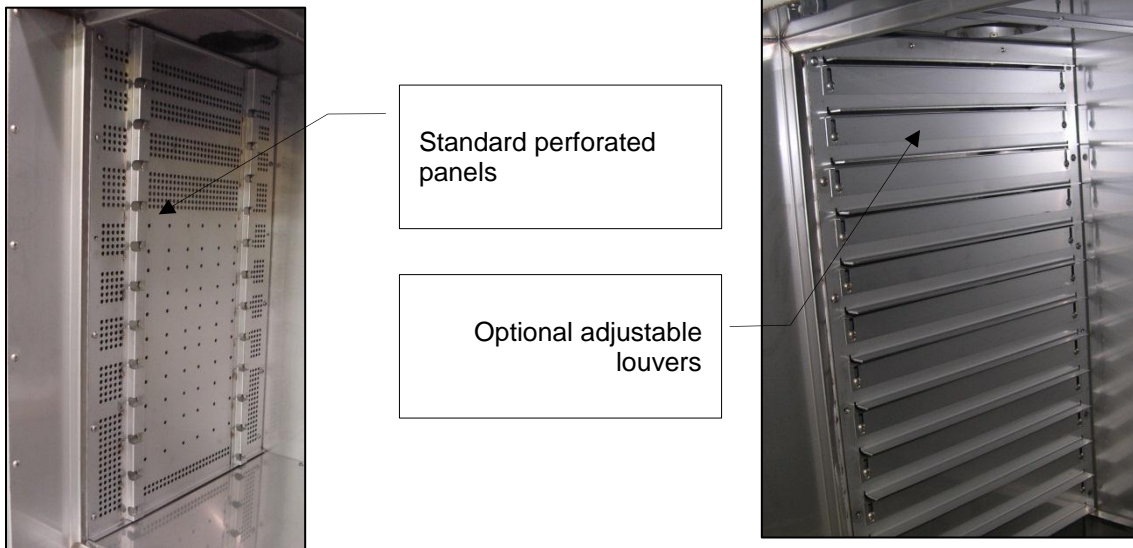

Figure 7. Standard perforated panels and adjustable louvers.

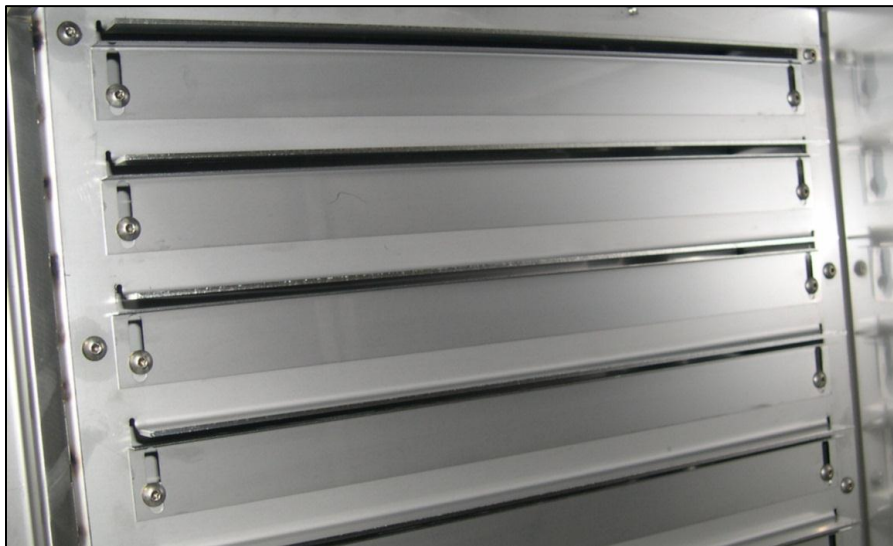

Figure 8. Initial factory settings for optional louvers.

Copyright © 2012 by Despatch Industries.

All rights reserved. No part of the contents of this manual may be reproduced, copied or transmitted in any form or by any means including graphic, electronic, or mechanical methods or photocopying, recording, or information storage and retrieval systems without the written permission of Despatch Industries, unless for purchaser's personal use.

3.3.1. Purpose of Adjustable Airflow

Optional adjustable airflow has several purposes in the RFD oven:

1. Ability to get the best temperature and airflow uniformity.
2. Ability to “spot heat” special areas or specific parts of load.
3. Ability to prevent air flowing out or sucking in through the entrance and exit openings in the oven.

3.3.2. Supply Air Adjustment

The adjustment of supply louvers is directly related to temperature uniformity in the work chamber. A general guideline is that more heat is required next to doors, windows and outside walls so, therefore, more air is required to deliver that heat.

3.3.3. Return Air Adjustment

Ensure there are no restrictive conditions which may limit the amount of air handled by the return ducts. Restrictions in return air ducts may decrease the amount of air handled by the fan and/or may result in pressurized conditions in the work chamber. The initial settings for return louvers should be 50% more open than the supply louvers. Final adjustment may be necessary.



Warning!

Maintain slight positive pressure to regulate heat.

Too much positive pressure in an oven can create a high outer skin temperature as hot air is forced out through panel joints and around door seal. High outer skin temperature could warp the front of the oven.

3.4. The Protocol 3 Controller

Notice

It is particularly important that the oven operators have a practical understanding of the automatic controls. These regulate the temperature, provide safety features and generally govern the consistently uniform and satisfactory performance of the oven.

The Protocol 3™ is a microprocessor based digital temperature controller designed for simple and flexible oven operation (Figure 9). The Protocol 3 controller operates as a dual-functioning

Copyright © 2012 by Despatch Industries.

All rights reserved. No part of the contents of this manual may be reproduced, copied or transmitted in any form or by any means including graphic, electronic, or mechanical methods or photocopying, recording, or information storage and retrieval systems without the written permission of Despatch Industries, unless for purchaser's personal use.

controller/High Limit instrument. The control portion utilizes a time proportioning voltage signal to control heating devices with minimal temperature fluctuations.

The High Limit portion protects the product and/or the oven from overheating. If the product being processed has a critical high temperature limit, the High Limit setpoint should be set to a temperature somewhat below the temperature at which the product could be damaged. If the product does not have a critical high temperature limit, the High Limit setpoint should be set 5 to 15 degrees higher than the maximum programmed setpoint at which the oven will operate.

	<i>The purchaser is responsible for setting the High Limit Control per the instructions in this manual.</i>
---	--

	<i>Danger!</i> <i>Failure to attend to High Limit Control Warning may result in property damage, serious bodily injury or death.</i>
---	---

The Protocol 3 controller provides three primary operating modes:

- Manual: Oven operates continuously at a fixed temperature until turned off.
- Timer: Oven operates at a fixed temperature for a user-selected time period, and then automatically turns off.
- Profile: Temperatures increase or decrease as defined by 255 segments that can be allocated to 64 ramp and soak profiles. The profiles can be linked to provide additional temperature combinations.

Review the Protocol 3 Controller Owner's Manual for more information.

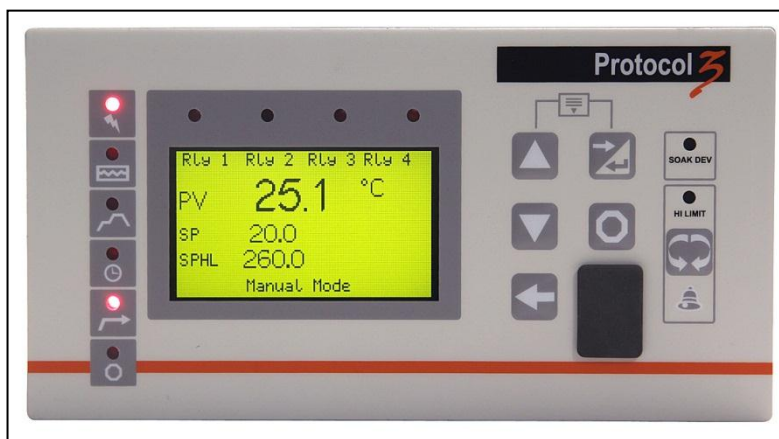

Figure 9. Protocol 3 Operator Interface.

3.5. Optional High Limit Audible Alarm

High Limit audible and visual alarm is a red light (Figure 13) and small alarm horn located on the front of the control panel. The alarm is sounded if a High Limit condition occurs. A switch is provided to silence the alarm. This alarm has a range of 80dB at 2 ft (0.6 m).

3.6. Purge Timer

The Purge timer (Figure 10) prevents the heater from energizing until flammable solvents within the oven have been reduced to a safe level by the forced exhaust system. The red light of the Purge timer illuminates during the purge cycle.

The Purge timer is pre-set at the factory for the appropriate purge time. Table 2 and the specification label (Figure 14) list the appropriate settings. Verify the setpoint before each use. If the purge time is not set to the value shown in Table 2 or on the specification label, adjust as necessary.

Table 2. Purge timer settings for various RFD models.

RFD Model	Purge Timer Setting
RFD2-13	4 minutes
RFD2-19	5 minutes
RFD2-35	2.5 minutes



Figure 10. The Purge timer red light is illuminated during the timing period.

3.7. Airflow Interlocking Safety Switch

The Airflow Interlocking Safety Switch interrupts power to the heater if the forced exhaust system is not functioning properly (Figure 11).

If the Airflow Interlocking Safety Switch is set too low, it will not interrupt power to the heater (if the forced exhaust system were not functioning properly). If the Airflow Interlocking Safety Switch is set too high, the heater will not energize, even if the forced exhaust system is functioning properly. The Airflow Interlocking Safety Switch setpoint is pre-set at the factory but must be verified before each use (see Section 6.5 for adjustment information).



Figure 11. Airflow interlocking safety switch.

Copyright © 2012 by Despatch Industries.

All rights reserved. No part of the contents of this manual may be reproduced, copied or transmitted in any form or by any means including graphic, electronic, or mechanical methods or photocopying, recording, or information storage and retrieval systems without the written permission of Despatch Industries, unless for purchaser's personal use.

4. Assembly & Setup

Assembly and Setup provides directions for unpacking and installing your RFD oven.

	<p>Danger!</p> <p><i>This equipment must be installed by a licensed electrician who is experienced with combustion safeguard control systems and understands the functions of an interlocking switch such as gas pressure switches.</i></p>
---	--

	<p><i>If any warning, danger, or information sign has been damaged or lost, contact the customer service department of Despatch Industries, Inc. for replacement.</i></p>
---	---

4.1. Unpack & Inspect The RFD Oven

Remove all packing materials or devices and thoroughly inspect the oven for any damage that might have occurred during shipment.

- Note the condition of the carton and plastic cover sheet inside the carton.
- Observe all outside surfaces and corners of the oven for scratches and dents.
- Check oven controls and indicators for normal movement, bent shafts, cracks, chips or missing parts such as knobs and lenses.
- Check the door and latch for smooth operation.

4.1.1. If Damaged During Shipping

If damage occurred during shipping:

1. Contact the shipper immediately and file a written damage claim.
2. Contact Despatch Industries (**1-800-473-7373** or **1-952-469-8230** or **service@despatch.com**) to report your findings and to order replacement parts for those damaged or missing. Send a copy of your filed damage claims to Despatch Industries (**Despatch Industries, 8860 207th Street, Lakeville, MN 555044, USA**).
3. **Street, Lakeville, MN 555044, USA**).
4. Check the packing list to ensure you received all the specified components of the oven system. Contact Despatch Industries to have any missing products forwarded to you.
5. Complete the warranty card and mail it to Despatch within 15 days after receipt of the equipment.

4.2. Set up The RFD Oven

4.2.1. Select Oven Location

The Despatch RFD oven is designed to operate in an industrial setting.

Copyright © 2012 by Despatch Industries.

All rights reserved. No part of the contents of this manual may be reproduced, copied or transmitted in any form or by any means including graphic, electronic, or mechanical methods or photocopying, recording, or information storage and retrieval systems without the written permission of Despatch Industries, unless for purchaser's personal use.

	<p>Warning!</p> <p><i>Do not use the oven in wet, corrosive or explosive atmospheres unless this oven is specifically designed for a special atmosphere.</i></p>
---	---

<p>Notice</p>	<p><i>Review oven weight to ensure the foundation is adequate to hold the weight.</i></p>
----------------------	---

4.2.1.1. Placement Requirements

- Place oven directly on the floor.
- Allow adequate clearance for explosion relief. Minimum clearance for explosion relief is 18 in. above the oven.
- Plumb and level the oven to assure proper heat distribution and operation of all mechanical components.
- Do not expose oven to excessive vibration and affix all electrical cabinets.
- If placing the oven in an area where excessive particulate matter exists (such as a construction site or coal processing center), periodically clean all its electrical compartments. Keep power supply within the specifications provided by Despatch, and use a line conditioner for a facility with an unstable power supply.

4.3. Exhaust Connections

The RFD oven exhaust discharge opening is located on the top left of the oven (Figure 12). Install an exhaust stack from the discharge opening to the outside of the building. The discharge opening size is 8.9 x 21.6 cm (3 ½ x 8 ½ inches).



Figure 12. RFD Forced Exhaust Assembly.

<p>Notice</p>	<p><i>If more than two elbows are used in the stack, over all airflow will be reduced. If airflow is reduced, the amount of solvent that can be safely used with the equipment must also be reduced.</i></p>
----------------------	--

Notice	<i>Flashing through roof or wall must be capable of handling temperatures up to 343°C (650°F).</i>
---------------	---

	<i>All stacks must comply with state and local building codes to ensure that surrounding combustible surfaces are below 71°C (160°F).</i>
---	--

4.4. Wiring & Power Connections

See electrical schematics in Section 8.3 for line connections.

	<i>The oven must be hardwired directly to the electric supply.</i>
---	---

	<i>Verify proper fan rotation on initial start-up and recheck rotation whenever wiring or electrical component changes are made. Each fan has an arrow showing correct rotation.</i>
--	---

	<i>Danger!</i> <i>All grounding and safety equipment must be in compliance with applicable codes, ordinances and accepted safe practices.</i>
---	--

5. Operation

	<p><i>Users and operators of this oven must comply with operating procedures and training of operating personnel as required by the Occupational Safety and Health Act (OSHA) of 1970, Section 5 and relevant safety standards, and other safety rules and regulations of state and local governments. Refer to the relevant safety standards in OSHA and National Fire Protection Association (NFPA), Section 86 of 1985.</i></p>
---	--

	<p>Danger!</p> <p><i>Class A ovens are designed for a specific amount of flammable solvent. Exceeding this amount could result in an explosion. Refer to Design Specification Label (Figure 2) or Section 1.5.2 for the solvent handling capabilities of this oven.</i></p>
---	--

	<p>Danger!</p> <p><i>In case of fire, leave door(s) as they are. Shut off electricity. Shut off fuel. Call the fire department. Stay away.</i></p>
---	---

5.1. Load Oven

	<p><i>Despatch Industries cannot be responsible for either the process or process temperature used, or for the quality of the product being processed. It is the responsibility of the purchaser and operator to see that the product undergoing processing in a Despatch oven is adequately protected from damage.</i></p> <p><i>Carefully following the instructions in this manual will help the purchaser and operator in fulfilling that responsibility.</i></p>
---	---

Avoid spilling on the heater elements or oven floor when loading the oven. Do not place the load on the oven floor plate. Placing the load on the oven floor may cause the load to heat unevenly and the weight may cause shorting out of the heater elements. Use the shelves provided.

Copyright © 2012 by Despatch Industries.

All rights reserved. No part of the contents of this manual may be reproduced, copied or transmitted in any form or by any means including graphic, electronic, or mechanical methods or photocopying, recording, or information storage and retrieval systems without the written permission of Despatch Industries, unless for purchaser's personal use.

	<p>Caution!</p> <p><i>Always place loads on the shelves provided to avoid possible uneven heating and damage to the oven.</i></p>
---	--

The two shelves are designed to be pulled out about halfway without tipping. Do not overload the shelves. Shelf support capacity is listed in the Capacities section (1.5.2). Do not overfill the oven. Distribute the workload evenly so airflow is not restricted. The workload should not take up more than two-thirds of any dimension of the inside cavity.

	<p>For best results:</p> <ul style="list-style-type: none">• Do not place the load within 7.62cm (3 inches) of louvers or within 15.25cm (6 inches) of the chamber ceiling• Stagger the load within the chamber to allow as much air as possible to circulate from the supply side to the return side of the oven
---	---

5.2. Pre-Startup Checklist

- Read this manual carefully and make use of its instructions and explanations. Safe, continuous, satisfactory and trouble-free operation depends primarily on your degree of understanding of the system and your willingness to keep all parts in proper operating condition.
- Verify line voltage. Voltage must correspond to nameplate requirements of motors and controls. Incorrect line voltage can result in serious damage. Refer to Section 1.5.4 for more information.
- Check fresh air and exhaust openings. The dampers have been designed to remain slightly open to allow processed solvent gases to escape. Do not be careless about restrictions in and around the fresh air and exhaust openings and stacks. Refer to Sections 1.5.2 and 4.3 for information on exhaust specifications and requirements. Under no condition can they be permitted to become so filled with dirt that they reduce airflow.
- For drying application, open exhaust damper to prevent buildup of moisture.

5.3. Operating Procedure

5.3.1. Check Fan Rotation and Other Preliminaries

	<p><i>If polarity is reversed during wiring, the fan will rotate backwards and compromise proper ventilation.</i></p>
---	--

1. Check fan rotation after the initial installation and after reconnecting the power supply to ensure the fans are running in the correct direction. To check fan rotation:
 - a. Momentarily toggle **POWER** (Figure 13) to start fans and check rotation.
 - b. Rotation should correspond to the directional arrows provided.
 - c. Reverse motor rotation where necessary.
2. Verify purge timer (Figure 10) is set to the correct value as it appears on the Design Specification (Figure 14) or Table 2.
3. Verify airflow switches:
 - a. Are properly installed
 - b. Proper make and break for the contacts when fans are started and stopped.
 - c. Refer to Section 3.7 and Section for 6.5 more information on airflow switches.

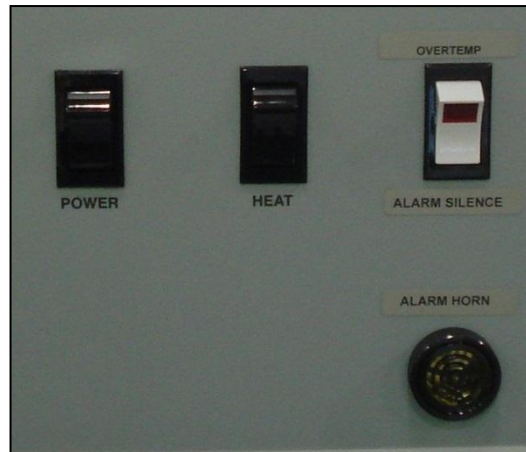

Figure 13. Power, Heat and Alarm Silence Switches.

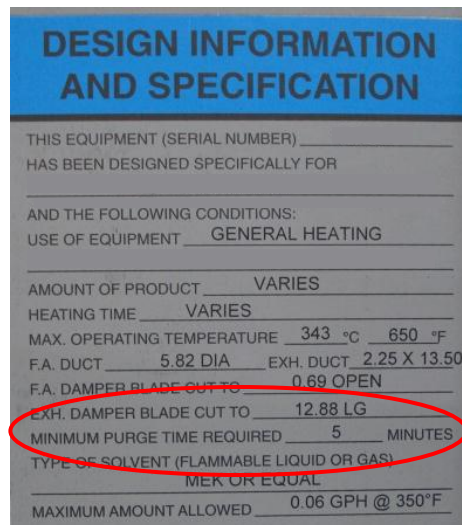

Figure 14. Minimum purge time is listed on the RFD oven design specification label.



Never operate oven at a temperature above the maximum operating temperature: 343°C (650°F)

5.3.2. Start and Operate the Oven

1. Set the main **Power Disconnect** switch to ON (Figure 3).
2. Set **POWER** to ON. The recirculation fan will start, and the purge timer will begin timing.

Notice

The heater of the Class A oven cannot be energized until the forced exhaust system has brought in a minimum amount of fresh air into the chamber. The purge timer provided prevents the heater from energizing until the oven has had enough time to bring in the required amount of fresh air. The airflow switch, which closes when the exhaust system is running, energizes the purge timer. The predetermined purge time for the RFD oven is specified in Section 3.6.

3. Set **HEAT** to ON (Figure 13).
 - a. The Heater LED on the controller will light indicate the heater is on and the controller is calling for heat.
 - b. The alarm horn will sound if the High Limit trips. Press the **ALARM SILENCE** to silence the alarm.
 - c. Allow the oven to cool below the High Limit setting and reset the High Limit.
4. When the door is opened the heater will shut off.
5. Operate the temperature control as desired. If necessary, refer to the Protocol 3 Owner's Manual for more instruction.

5.3.3. Shutdown

1. Set **HEATER** to OFF.
2. Allow the fans to run until the oven has cooled below 149°C (300°F).
3. Set **POWER** to OFF.



Warning!

Fans should remain in operation until the oven temperature is below 149°C (300°F) to prevent damage to the fan and/or motor bearings.

If additional information is required regarding the operation of this equipment, please contact Despatch.

Global Headquarters	Contact	Service & Technical Support
Despatch Industries 8860 207th Street Lakeville, MN 55044 USA	International/Main: 1-952-469-5424 US toll free: 1-888-337-7282 Fax: 1-952-469-4513 info@despatch.com www.despatch.com	Service: 1-952-469-8230 US toll free: 1-800-473-7373 Service @despatch.com

5.3.4. Working with Protocol 3 Operating Modes

Refer to the Protocol 3 Controller's Owner Manual for specific information for working with the controller.

6. Maintenance

Do not attempt any service on this oven before setting the main power **Disconnect Switch** to OFF.

	<p><i>Danger!</i></p> <p><i>Disconnect all power sources before making repairs. Contact with energized electrical sources may result in serious injury or death.</i></p>
---	--

6.1. Checklist

- Keep equipment clean. Gradual dirt accumulation retards airflow. A dirty oven can result in unsatisfactory operation such as unbalanced temperature in the work chamber, reduced heating capacity, reduced production, and the like. Keep the walls, floor and ceiling of the oven work chamber free of dirt, dust, smoke, solvent vapors, or other contaminations.
- Keep all equipment accessible. Allow space for good circulation. Do not permit other materials to be stored or piled against it.
- Do not place load too close to the supply duct. The supply air temperature is somewhat higher than average work space temperature and may overheat or otherwise damage product.
- Do not put product on the floor or in isolated corners where air movement and temperature are not likely to be at average conditions.
- Do not mix thick heavy parts with light parts. The heavy parts require longer to heat and should be treated separately.
- Check safety controls. This should be done daily and never less than once a week. Establish maintenance and checkup schedules. Maintain equipment in good repair and adjustment at all times. Make repairs immediately to avoid costly delays.

6.2. Maintenance Schedule

Preventive Maintenance (Refer to Section)	Daily	Weekly	Monthly	Every Three Months	Every Six Months	Annually	As Needed
General							
Avoid placing load too close to supply duct (5.1)	X						
Visually inspect for dirt, debris and free movement of parts and controls.				X			
Clean as needed							X
Inspect door seals for proper seating, damage and/or tears			X				
Inspect door operation. Doors should open and close securely, without jerking or slamming.			X				
Check optional Disconnect Switch (2.5.1)					X		
Time to temperature: record heating times for similar loads. If heating times are slowing, it could indicate a need for maintenance.			X				
Ventilation							
Check fresh air damper (3.2)			X				
Check fan vibration: supply and exhaust (6.3)			X				
Inspect optional louvers (3.3)			X				
Check fan rotation (5.3.1)							X
Electrical							
Test airflow switch (6.5)				X			

Copyright © 2012 by Despatch Industries.

All rights reserved. No part of the contents of this manual may be reproduced, copied or transmitted in any form or by any means including graphic, electronic, or mechanical methods or photocopying, recording, or information storage and retrieval systems without the written permission of Despatch Industries, unless for purchaser's personal use.

Preventive Maintenance (Refer to Section)	Daily	Weekly	Monthly	Every Three Months	Every Six Months	Annually	As Needed
Check High limit controller (6.8)				X			
Verify purge timer setting (6.4)				X			

6.3. Check Fans

Check fan operation by closely observing for abnormal movement or sound. Irregular noise or movement may mean the fan needs repair or replacement. Listen for any irregular noises coming from the fans.

6.4. Test Purge Timer

Test the Purge timer regularly to ensure continued safe operation:

1. Check the minimum purge time setting on the RFD Oven name plate (Figure 14).
2. Verify the Purge timer is set to the setting on the RFD name plate (Figure 10).

6.5. Test Airflow Switch

Testing the airflow switch ensures that power to the heater is interrupted if the forced exhaust system is not functioning properly. This section provides an example test procedure along with a procedure for adjusting the airflow switch. If testing or adjusting the airflow switch prove unsuccessful, contact Despatch for service information (see Section 1.2).

6.5.1. To Set or Adjust Airflow Switch

The position of the top of the adjustment screw indicates the switch pressure setting. View the pressure setting through the slot in the stem (Figure 16). To adjust the airflow switch:

1. Remove the aluminum hex cap on the top of the stem (Figure 16).
2. Increase the setting by turning the inside adjustment screw clockwise (adjustment screw down).
3. Decrease the setting by turning the inside adjustment screw counter-clockwise (adjustment screw up).

6.5.2. Example: Verify Exhaust Fan Airflow Switch Setpoint

To test the exhaust fan's airflow switch setpoint:

1. Set the oven power to ON.

2. Allow the oven to stabilize at its minimum operating temperature by leaving the heater off.
3. Set the oven power to OFF.
4. Verify that the white line in the indicator window of the airflow switch is OFF (Figure 15).
 - a. If the switch remains ON, increase the airflow switch set point until the switch turns OFF.
 - b. A switch setting of 0.2" WC (inches of water column) to 1.0" WC should detect a fan malfunction.
 - c. If the switch does not shut off below a setting of 2" WC, the switch is defective.
 - d. Once the switch turns off, increase the setpoint an additional 0.2" WC.
5. Set the oven power to ON to start the exhaust fan.
6. Verify that the white line in the indicator window of the airflow switch is ON and steady (Figure 15).
7. If the switch remains OFF, check the fan rotation direction (Section 5.3.1). If the fan rotation is correct, decrease the airflow switch set point until the switch turns on.

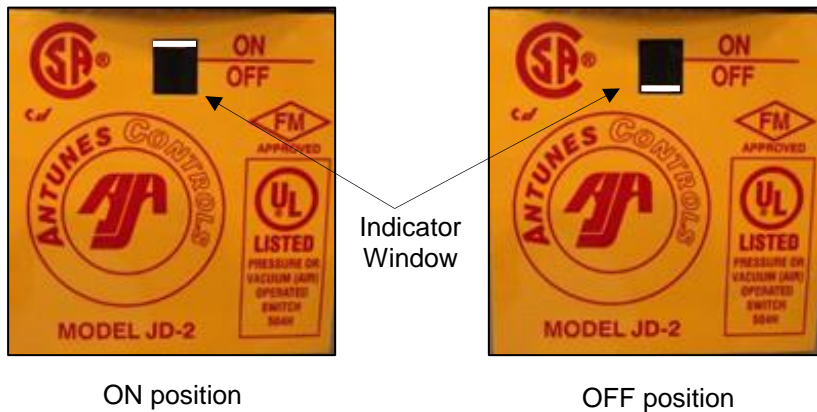

Figure 15. Airflow Switch Indicator.

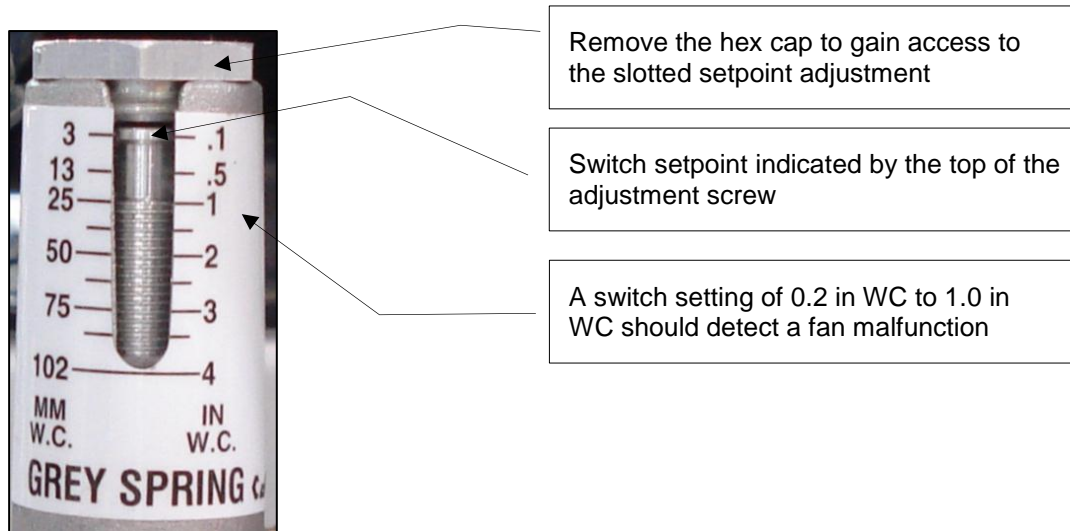

Figure 16. Adjust the airflow switch.

6.6. Lubrication

Lubricate all door latches, hinges, door operating mechanisms, and wear surfaces to ensure easy operation.

6.7. Check Safety Controls

Make certain the oven controls are free of dirt and debris and function properly.

6.8. Check High-Limit Controller

The Protocol 3 controller has an integrated high limit function which disables the heater output when tripped. Check the High Limit controller by:

1. Set the Hi-Limit setpoint below the process temperature. Refer to the Protocol 3 manual as necessary.
2. The oven should heat and trip the High-Limit controller as it reaches the high limit setpoint.
3. If not, contact Despatch.

6.9. Replacement Parts

	<p>Danger!</p> <p><i>Do not attempt any service on this equipment without setting the main power Disconnect Switch to OFF. Disconnect all power sources before making repairs. Contact with energized electrical sources may result in serious injury or death.</i></p>
---	--

Contact the Service Products Division at Despatch to order or return parts. The Service Products features our Response Center for customer service. When returning parts, a Despatch representative will provide you with an MRA (Material Return Authorization) number, which must be attached to the returned part for identification.-When ordering a replacement part, be sure to give the model number, serial number, and part number to expedite the process.

Contact Despatch with any service needs.

Global Headquarters	Contact	Service & Technical Support
Despatch Industries 8860 207th Street Lakeville, MN 55044 USA	International/Main: 1-952-469-5424 US toll free: 1-888-337-7282 Fax: 1-952-469-4513 info@despatch.com www.despatch.com	Service: 1-952-469-8230 US toll free: 1-800-473-7373 Service @despatch.com

6.10. Repairs

6.10.1. Protocol 3 Controller

Refer to the Protocol 3 Owner's Manual for instructions on replacing the Protocol 3 Controller.

7. Troubleshooting

7.1. Troubleshooting: Possible Problems and Solutions

Equipment which operates for long periods of time may develop problems. Table 3 lists possible problems and suggested solutions. If you have a problem not listed and do not know what to do, contact Despatch Industries at our toll free **Help Line 800-473-7373**.

Table 3. Troubleshooting grid.

Difficulty	Probable Cause	Suggested Remedy
Failure to heat or heats up to only 35-50°C	No power	Check power source and/or oven and wall fuses
	Burned out heater	Replace heater (see warranty, Section 8.1)
	Protocol 3 controller malfunction	Replace controller
	Loose wire connections	Disconnect power and check connections behind control panel
	Heater relay failure	Replace heater contactor or SCR
	Door switch failure (if installed)	Replace door switch
Slow heat up	Improperly loaded	Reduce load or redistribute load in chamber.
	Low line voltage	Supply sufficient power and proper connections. Check for circuit overload
	Heating element(s) are burned out	Replace heater (see warranty, Section 8.1)
	Fan motor failure	Replace fan motor
Frequent heater element burnout	Harmful fumes generated by load	Increase vent opening or discontinue process
	Spillage or splattering of material on heater elements	Disconnect power and clean oven chamber. Take measures to prevent splattering.
	Overheating oven	Check the High Limit
Erratic temperature or inaccurate temperature	Protocol 3 controller malfunction	Replace controller
	Improper tuning parameters	Check tuning parameters
	Protocol 3 controller miscalibration	Recalibrate controller (see Protocol 3 Controller Owner's Manual for further instruction manual).
	High Limit setting	High Limit should be 10-25°C higher than setpoint.
	Defective SCR	Replace SCR
	Improper offset	Check zone calibration
Excess surface or door temperature	Door seal deterioration	Replace door seal.
Improper airflow	Fan motor failure	Replace fan motor
	Fan wheel seated too low	Adjust fan wheel for 3/16" clearance between

Copyright © 2012 by Despatch Industries.

All rights reserved. No part of the contents of this manual may be reproduced, copied or transmitted in any form or by any means including graphic, electronic, or mechanical methods or photocopying, recording, or information storage and retrieval systems without the written permission of Despatch Industries, unless for purchaser's personal use.

Difficulty	Probable Cause	Suggested Remedy
	on fan shaft	wheel and inlet ring
	Unbalanced fan wheel	Replace fan wheel
<hr/>		
Excessive vibration	Dirty fan wheel	Clean fan
	Unbalanced fan wheel	Replace fan wheel
<hr/>		
Oven will not control at setpoint	High Limit set too low	Set the High Limit higher.
	Protocol 3 controller malfunction	Replace controller
	SCR malfunction	Replace SCR and/or check control output voltage.
	Air friction of recirculation fan	Open exhaust air vent. Unit will not control below minimum operating temperature with vent closed.
<hr/>		
Heater does not shut down until temperature reaches the High Limit setting	Protocol 3 controller malfunction	Replace controller.
	SCR malfunction	Replace SCR



Danger!

Electrical panels contain high voltage. Disconnect and lock out the power supply before working inside any electrical panels. Failure to lock out the power supply can result in death or injury.

7.2. Troubleshoot Airflow Conditions

Table 4 lists possible problems and remedies for airflow conditions.

Table 4. Airflow Troubleshooting.

Conditions	Actions
A. Non-uniform work chamber	<ol style="list-style-type: none"> 1. Check to get a lightly positive chamber pressure by closing down exhaust or opening up fresh air. <ol style="list-style-type: none"> a. Review damper instructions (Section 3.2) b. Adjust optional supply louvers: <ol style="list-style-type: none"> i. Open for cold spots ii. Close for hot spots c. If necessary, adjust optional return louvers in the same manner.

Copyright © 2012 by Despatch Industries.

All rights reserved. No part of the contents of this manual may be reproduced, copied or transmitted in any form or by any means including graphic, electronic, or mechanical methods or photocopying, recording, or information storage and retrieval systems without the written permission of Despatch Industries, unless for purchaser's personal use.

Conditions	Actions
	2. Check motor for proper operation and direction of rotation.
B. Cold by door	1. See A-1. 2. Check door seals. 3. Open optional supply louvers close to door.
C. Positive pressure in chamber	4. Close fresh air damper. 5. Open exhaust damper. 6. Refer to Damper Control Section 3.2 for more information.
D. Negative pressure in chamber	1. Close exhaust damper. 2. Open fresh air damper. 3. Open optional supply louvers slightly.

7.3. Troubleshooting: Error Messages and Alarm

Table 5 lists the more common error messages, the possible problems and remedies.

Table 5. Error Messages and Next Steps.

Alarm Status	Possible Problem	Next Step
HI LIMIT LED ON	<ul style="list-style-type: none"> Problem with thermocouple High Limit setpoint has been exceeded. 	Once the problem has corrected, press RESET .
DEV HOLD LED flashing	Oven temperature has not entered (or dropped out of) the Auto Hold band and the soak timer has stopped	Program a slower ramp rate or if oven is not heating check heater circuit.
Top PV displays OPEN	Control thermocouple is disconnected or broken	Repair or replace the thermocouple.
HLPV displays OPEN	High Limit thermocouple is disconnected or broken	Repair or replace the thermocouple.

8. Appendices

8.1. Standard Products Warranty



Despatch
INDUSTRIES

**Standard Products
Product Warranty**

Products Covered by this Warranty

This warranty (the "Warranty") applies to the following Despatch products: LEB, LBB, LAC, LCC, LCD, LLC, LLD, RAD, RFD, LND, TAD, TFD, PN, PTC, FCC, 900 Series.

Parts and Materials

Despatch warrants all parts and materials to be free from defects in material and workmanship for a period of:

- five (5) years from date of shipment for laboratory oven electric heaters;
- three (3) years from date of shipment for Protocol Plus, Protocol 3 and DES 2000 temperature controllers; and
- one (1) year from the date of shipment, or 2,000 hours of operation, whichever occurs first, for all other components of products covered by this Warranty.

During the applicable Warranty period, Despatch will repair or replace, at Despatch's option, parts and materials covered by this Warranty.

Labor

During the first 90 days of the Warranty period, Despatch will pay labor costs incurred to remove defective parts and materials, and to reinstall repaired or replacement parts or materials; provided, however, that Despatch's obligation to pay such labor costs shall be subject to the limitation that the removal and/or reinstallation service must be performed by a Despatch-authorized technician from Despatch's worldwide network of factory-trained professionals at a location within the contiguous United States.

Transportation Costs

All transportation costs to transport defective parts or materials to Despatch, and to transport repaired or replacement parts or materials to Customer, shall be the responsibility of the Customer.

Terms and Conditions

This Warranty shall be deemed valid and binding upon Despatch if and only if the Customer:

- installs, loads, operates, and maintains the covered product supplied hereunder in accordance with the instruction manual provided upon delivery and product labeling affixed to the subject equipment;
- if applicable, follows the Emergency Procedure set forth in this Warranty; and
- contacts Despatch's Helpline at 1-800-473-7373 for assistance in diagnosing and troubleshooting the problem immediately upon discovering any damage or malfunction.

Despatch's reasonable determination as to whether a repair, replacement, or service is covered by this Warranty shall be final and binding.

Exclusions

This Warranty DOES NOT cover:

- damage or malfunctions, or expenses incurred in the process of diagnosing and/or repairing damage or malfunctions, resulting from any of the following: operator error, misuse, abuse, inadequate preventive maintenance, normal wear and tear, service or modifications by other than Despatch

authorized technicians, use of the covered product that is inconsistent with the operation manual or labeling, acts of nature (including, without limitation, floods, fire, earthquake, or acts of war or civil emergency), internal or external corrosion, or non-conforming utilities (including, without limitation, electrical, fuel supply, environmental and intake/exhaust installations);

- repair or replacement of parts or materials designed and intended to be expendable or consumable; refrigerants, filters, lamps;
- routine maintenance; or
- labor costs incurred for troubleshooting, diagnostics, or testing (except for testing required to verify that a covered defective part or material has been repaired).

Limitations of Liability

Despatch shall not, in any event, be liable for indirect, special, consequential, incidental, or punitive damages or penalties of any kind, including, without limitation loss of revenue, profits or business opportunities resulting from interruption of process or production. In no event shall Despatch be liable for damages in excess of the amounts paid by Customer to Despatch with respect to the applicable product(s). This Warranty does not cover, and Despatch shall not be liable for any losses, costs, damages or expenses resulting from delays in diagnosing or repairing the products, supplying or obtaining replacement parts or materials, strikes, labor stoppages or shortages, fires, accidents, government acts or regulations, or any other causes beyond the control of Despatch.

Non-Compliance By Customer

Despatch reserves the right to suspend and withhold service under this Warranty in the event of non-compliance by the Customer to any terms and conditions of this Warranty or the applicable purchase order or invoice. Further, Despatch shall not be liable for any loss of production, expenses, and inconveniences incurred due to such suspension.

Customer Furnished Equipment Warranty Limitation

This Warranty does not cover diagnosis or repairs of defects in or caused by, lack of performance of, or fitness for purpose of customer-supplied parts or equipment unless specifically noted in the Despatch written order acceptance confirmation.

Performance Commitment

Despatch provides no guarantee of process performance or fitness for purpose, unless specifically noted otherwise in Despatch written order acceptance confirmation. Despatch is providing equipment with design parameters specific only to its equipment.

Procedure Upon Discovery of Defects and Emergencies

In the event Customer becomes aware of any defect in the applicable products, Customer must immediately: (a) shut off fuel or energy supply (gas and electricity), (b) call for emergency assistance, if needed, and (c) notify Despatch Service.

THE REPRESENTATION AND WARRANTIES SET FORTH HEREIN ARE EXCLUSIVE AND IN LIEU OF, AND CUSTOMER HEREBY WAIVES AND DISCLAIMS RELIANCE UPON, ALL OTHER REPRESENTATIONS AND WARRANTIES OF EVERY KIND WHATSOEVER, WHETHER EXPRESS OR IMPLIED, OR ARISING BY OPERATION OF LAW OR IN EQUITY, OR BY COURSE OF PERFORMANCE OR DEALING OR USAGE OF TRADE, INCLUDING, WITHOUT LIMITATION, ANY IMPLIED WARRANTIES OF MERCHANTABILITY OR OF FITNESS FOR A PARTICULAR PURPOSE.

THIS WARRANTY IS PERSONAL TO THE CUSTOMER AND MAY NOT BE TRANSFERRED OR ASSIGNED. ALL LIMITATIONS HEREUNDER, HOWEVER, SHALL BE BINDING ON ALL SUCCESSORS AND ASSIGNS OF CUSTOMER.

Service
Phone 800-473-7373; International Phone 952-469-8230; Fax 952-469-8193
e-mail service@despatch.com; www.despatch.com

Please see reverse side for other service offerings BB7 (12/30/08)

8.2. MRC5000 Setup (Optional)

	<p>Refer to instructions provided recorder manufacturer for more specific installation notes.</p>
---	--

Temperature is retransmitted to the MRC5000 recorder from the controller. Set up the recorder by:

1. Ensure hardware jumper JU1 is in place for the 5 VDC setting (Refer to MRC5000 Manual included).
2. Move MODE to **PROG/TEST/CAL** to display **Prog**.
3. Press ▼ twice to display **Inps**. Move to each Parameter Code using ▼ or ▲. Adjust each Parameter Code using the settings in Table 6.
4. After adjusting all settings, move MODE to **RUN**. Display on both the recorder and controller should read the same.

Table 6. MRC 5000 Settings.

Parameter Code	Degrees C	Degrees F
Inps	17	17
Icor	0	0
DiSP	On	On
Dpos	0	0
EUU4	400	752
EUL ⁴	0	32
ChUP	400	800 ⁵
ChLO	0	0
DFF	1	1

8.3. Electrical Schematics

The following pages contain electrical schematics for the RFD2-13, 2-19 and 2-35 ovens.

⁴ These values must match the settings **RetOutLo** and **RetOutHi** on the Protocol 3 Control page. For example, if **RetOutLo** is 32, **EUL** must read 32.

⁵ Change 0-400 chart paper to 0-800 chart paper. Depending on the equipment, 0-600 paper may be used if the maximum temperature is 260°C (500°F).

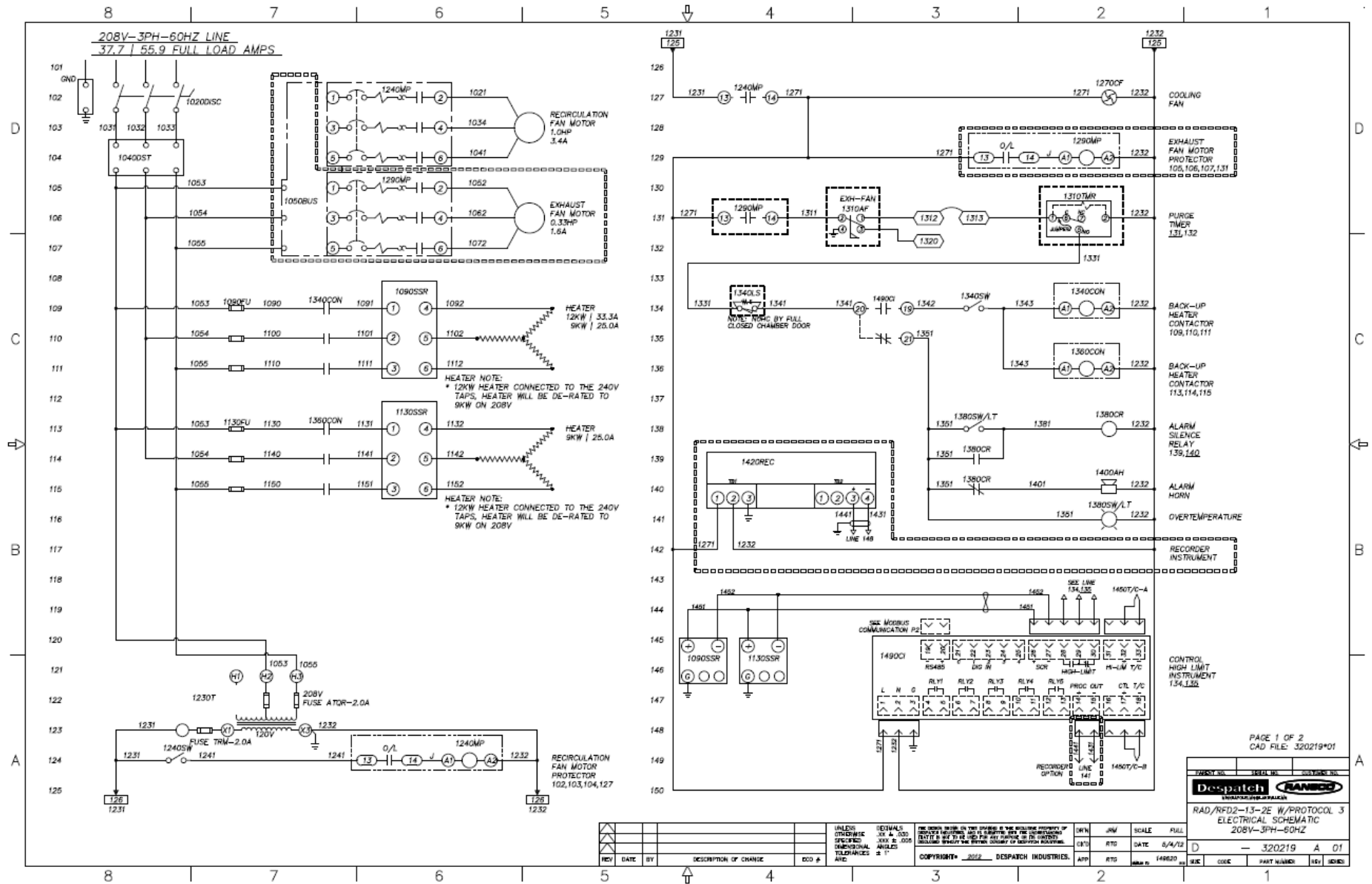

Figure 17. RFD2-13-2E, 208V (Drawing 320219-01).

Copyright © 2012 by Despatch Industries.

All rights reserved. No part of the contents of this manual may be reproduced, copied or transmitted in any form or by any means including graphic, electronic, or mechanical methods or photocopying, recording, or information storage and retrieval systems without the written permission of Despatch Industries, unless for purchaser's personal use.

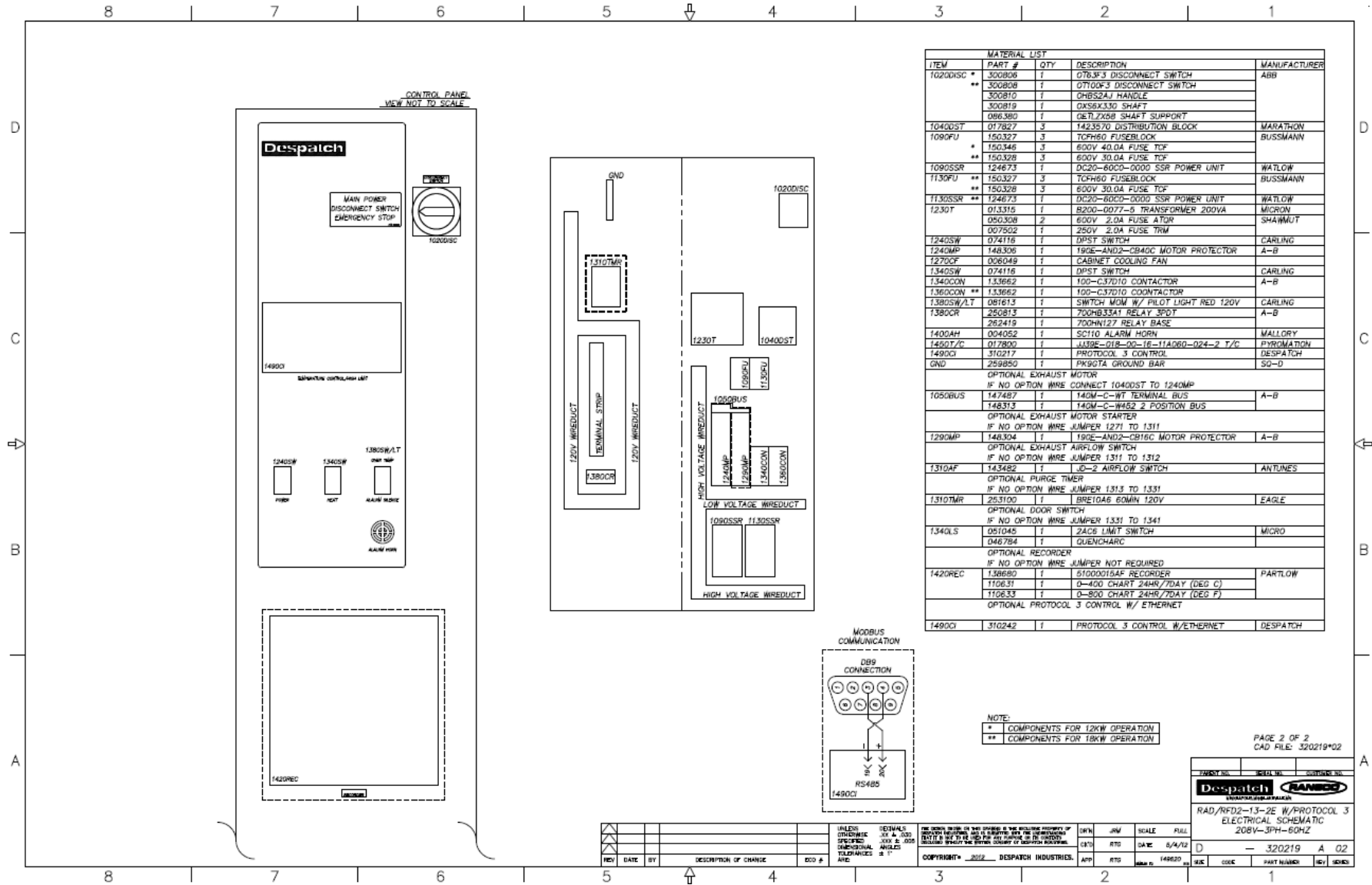

Figure 18. RFD2-13-2E, 208V (Drawing 320219-02).

Copyright © 2012 by Despatch Industries.

All rights reserved. No part of the contents of this manual may be reproduced, copied or transmitted in any form or by any means including graphic, electronic, or mechanical methods or photocopying, recording, or information storage and retrieval systems without the written permission of Despatch Industries, unless for purchaser's personal use.

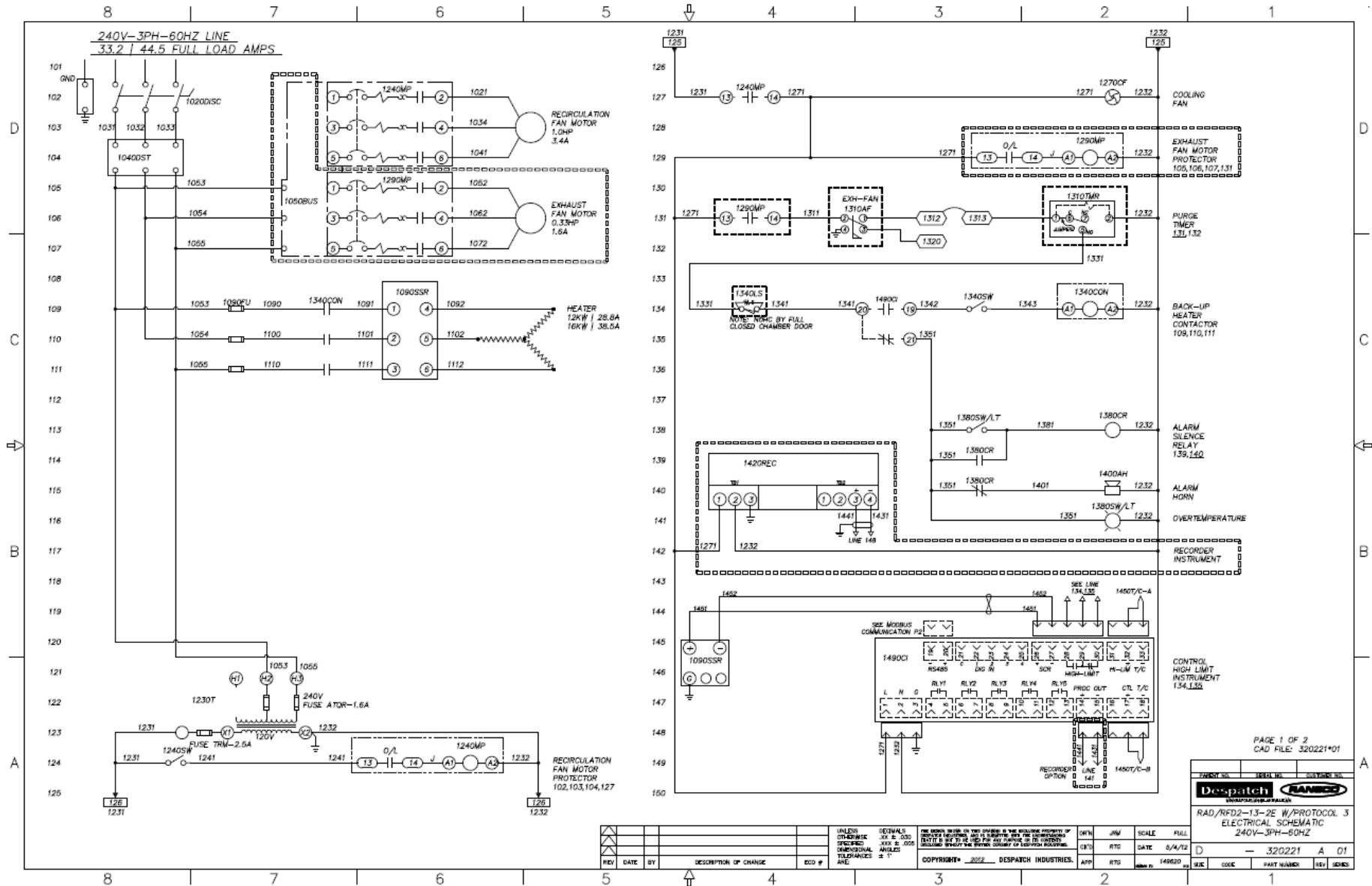

Figure 19. RFD2-13-2E, 240V (Drawing 320221-01).

Copyright © 2012 by Despatch Industries.

All rights reserved. No part of the contents of this manual may be reproduced, copied or transmitted in any form or by any means including graphic, electronic, or mechanical methods or photocopying, recording, or information storage and retrieval systems without the written permission of Despatch Industries, unless for purchaser's personal use.

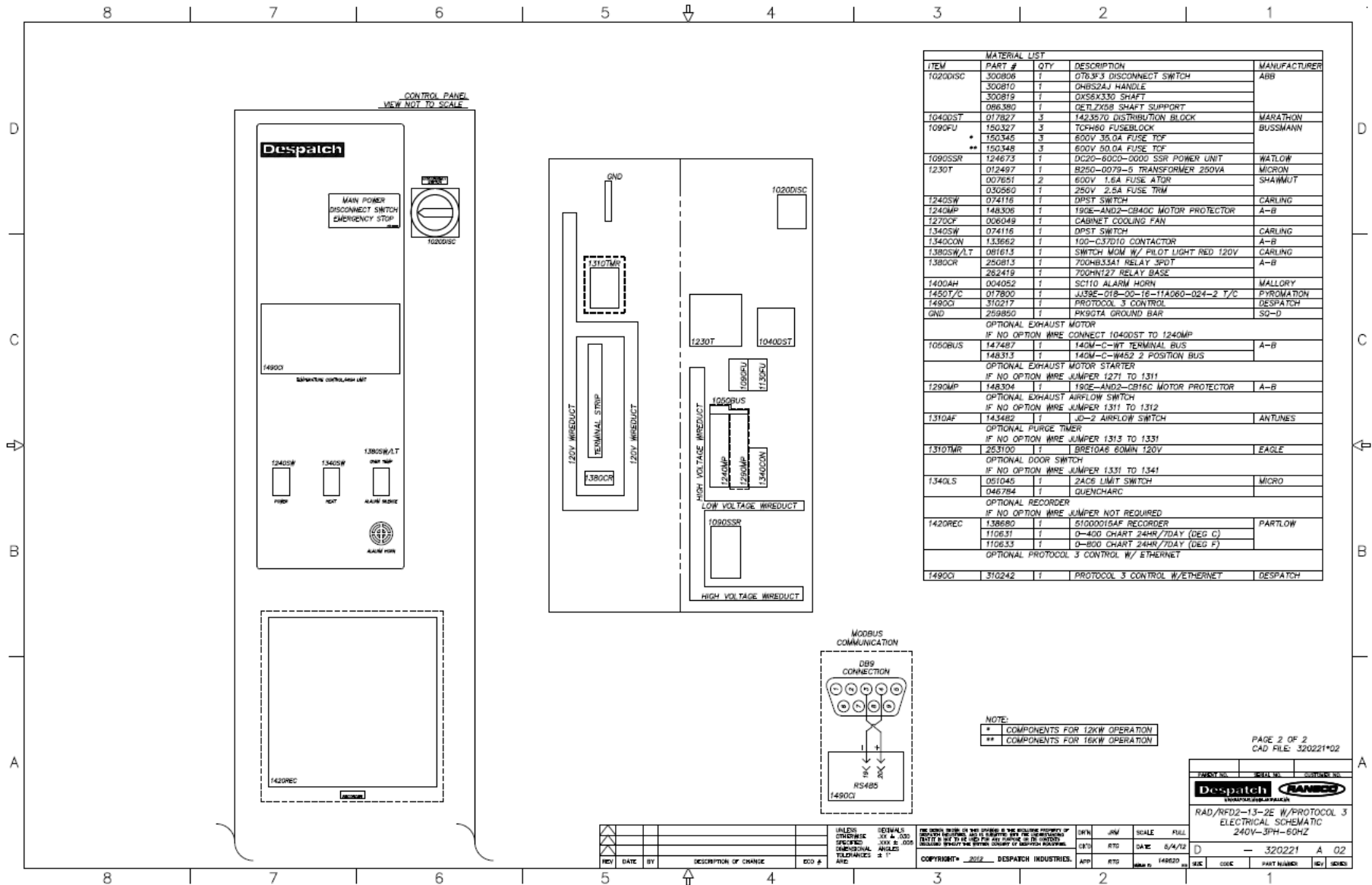

Figure 20. RFD2-13-2E, 240V (Drawing 320221-02).

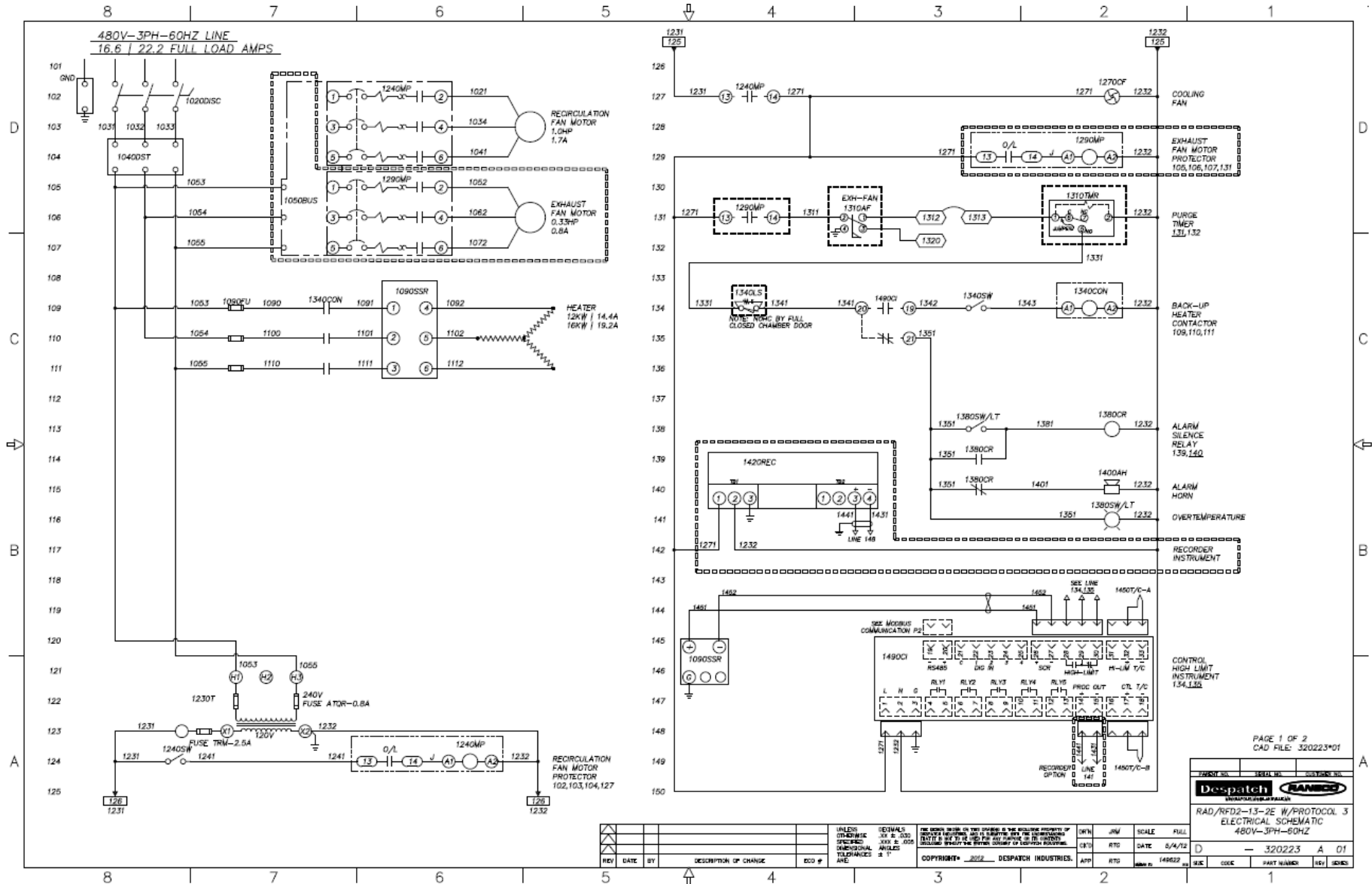

Figure 21. RFD2-13-2E, 480V (Drawing 320223-01).

Copyright © 2012 by Despatch Industries.

All rights reserved. No part of the contents of this manual may be reproduced, copied or transmitted in any form or by any means including graphic, electronic, or mechanical methods or photocopying, recording, or information storage and retrieval systems without the written permission of Despatch Industries, unless for purchaser's personal use.

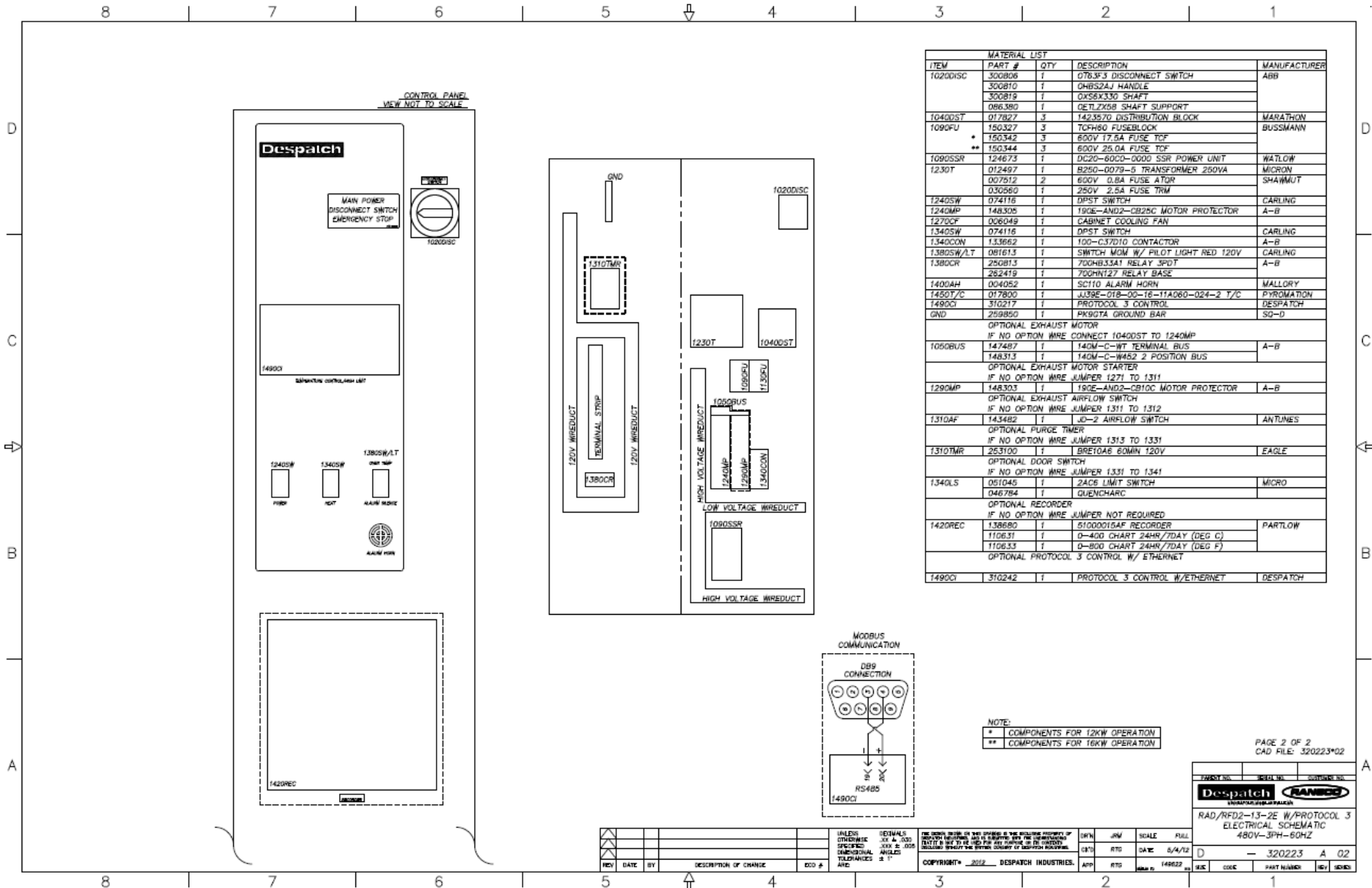

Figure 22. RFD2-13-2E, 480V (Drawing 320223-02).

Copyright © 2012 by Despatch Industries.

All rights reserved. No part of the contents of this manual may be reproduced, copied or transmitted in any form or by any means including graphic, electronic, or mechanical methods or photocopying, recording, or information storage and retrieval systems without the written permission of Despatch Industries, unless for purchaser's personal use.

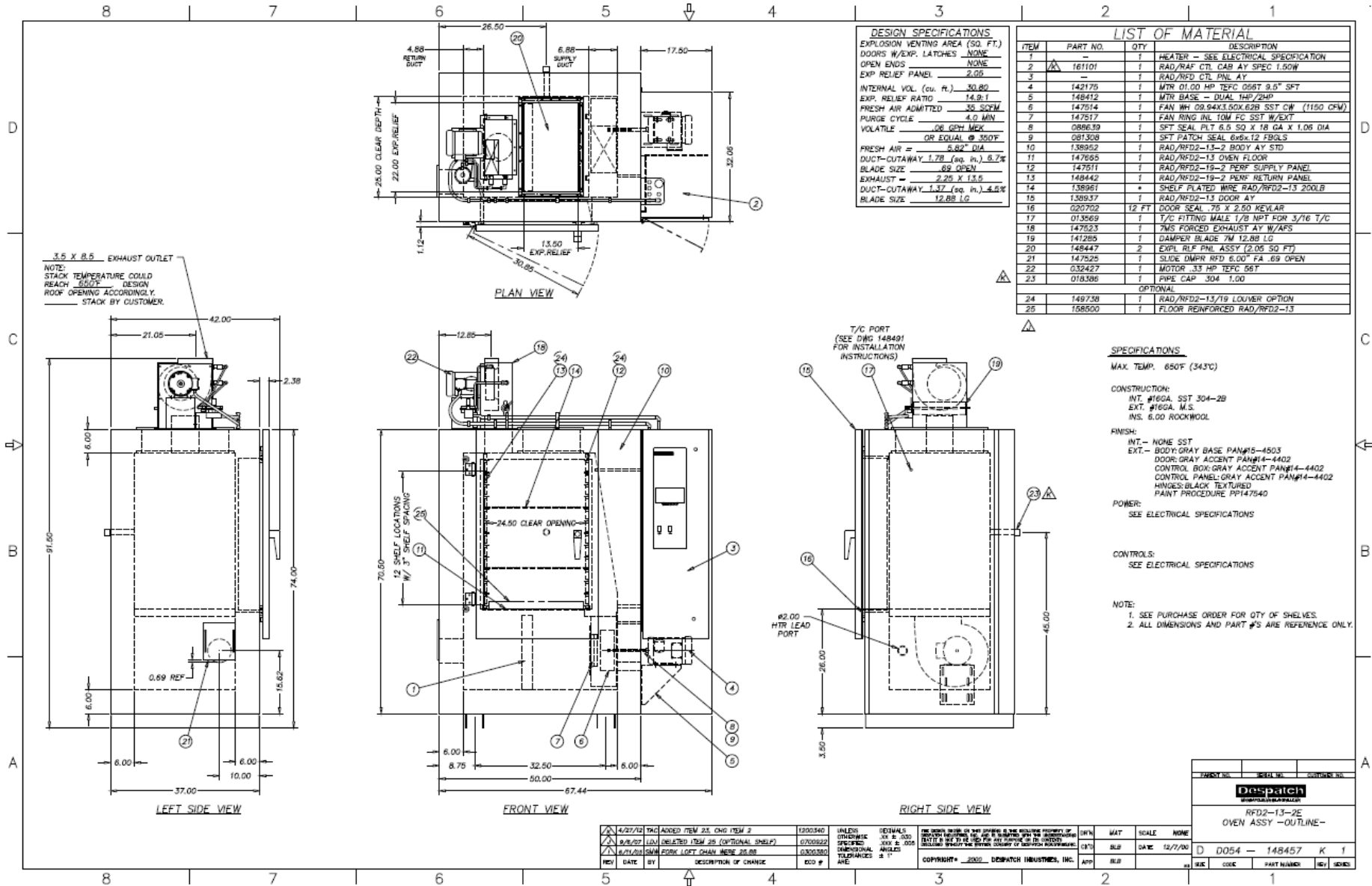

Figure 23. RFD2-13-2E Oven Assembly (Drawing 148457-01).

Copyright © 2012 by Despatch Industries.

All rights reserved. No part of the contents of this manual may be reproduced, copied or transmitted in any form or by any means including graphic, electronic, or mechanical methods or photocopying, recording, or information storage and retrieval systems without the written permission of Despatch Industries, unless for purchaser's personal use.

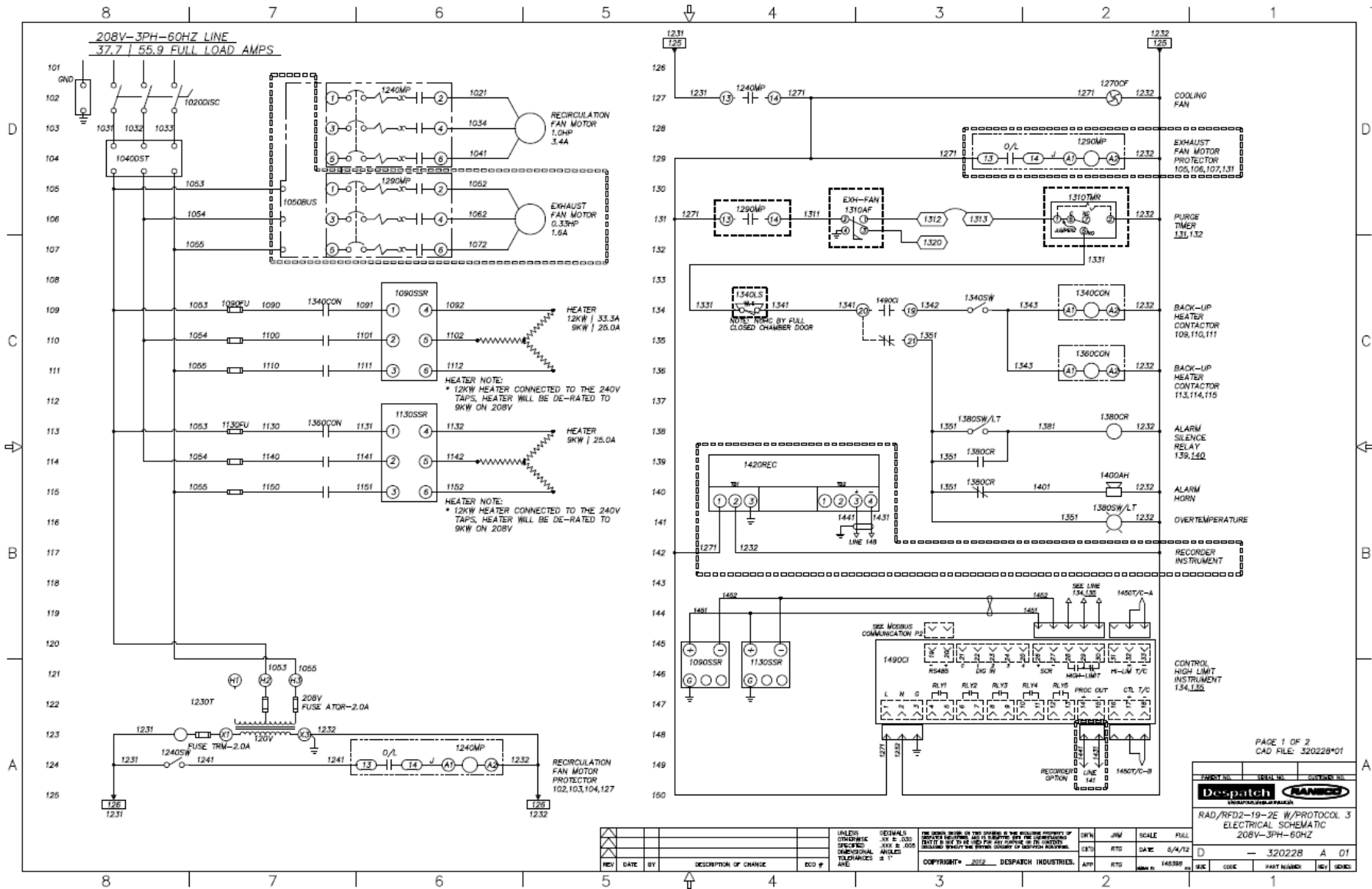

Figure 24. RFD2-19-2E, 208V (Drawing 320228-01).

Copyright © 2012 by Despatch Industries.

All rights reserved. No part of the contents of this manual may be reproduced, copied or transmitted in any form or by any means including graphic, electronic, or mechanical methods or photocopying, recording, or information storage and retrieval systems without the written permission of Despatch Industries, unless for purchaser's personal use.

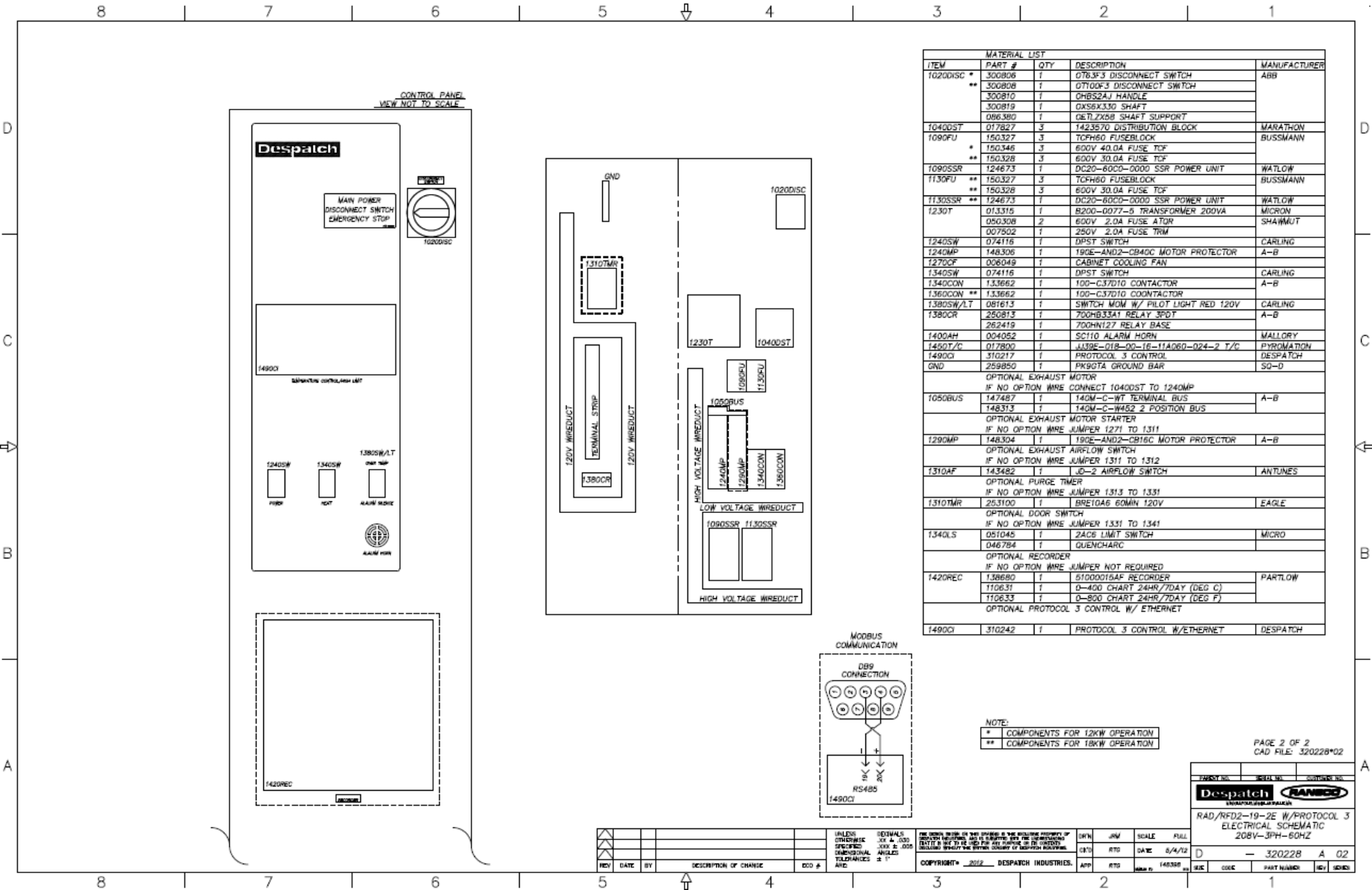

Figure 25. RFD2-19-2E, 208V (Drawing 320228-02).

Copyright © 2012 by Despatch Industries.

All rights reserved. No part of the contents of this manual may be reproduced, copied or transmitted in any form or by any means including graphic, electronic, or mechanical methods or photocopying, recording, or information storage and retrieval systems without the written permission of Despatch Industries, unless for purchaser's personal use.

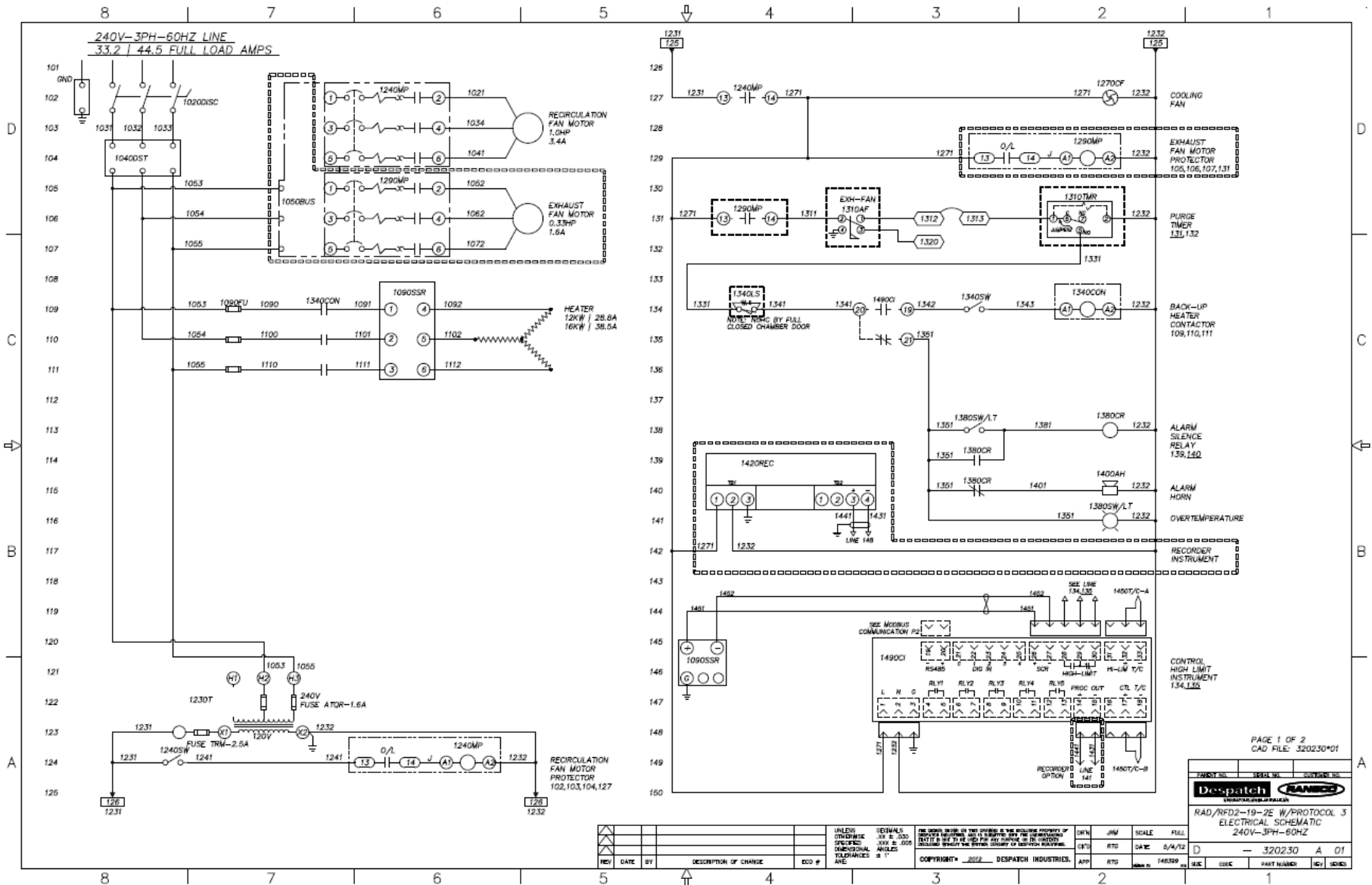

Figure 26. RFD2-19-2E, 240V (Drawing 320230-01).

Copyright © 2012 by Despatch Industries.

All rights reserved. No part of the contents of this manual may be reproduced, copied or transmitted in any form or by any means including graphic, electronic, or mechanical methods or photocopying, recording, or information storage and retrieval systems without the written permission of Despatch Industries, unless for purchaser's personal use.

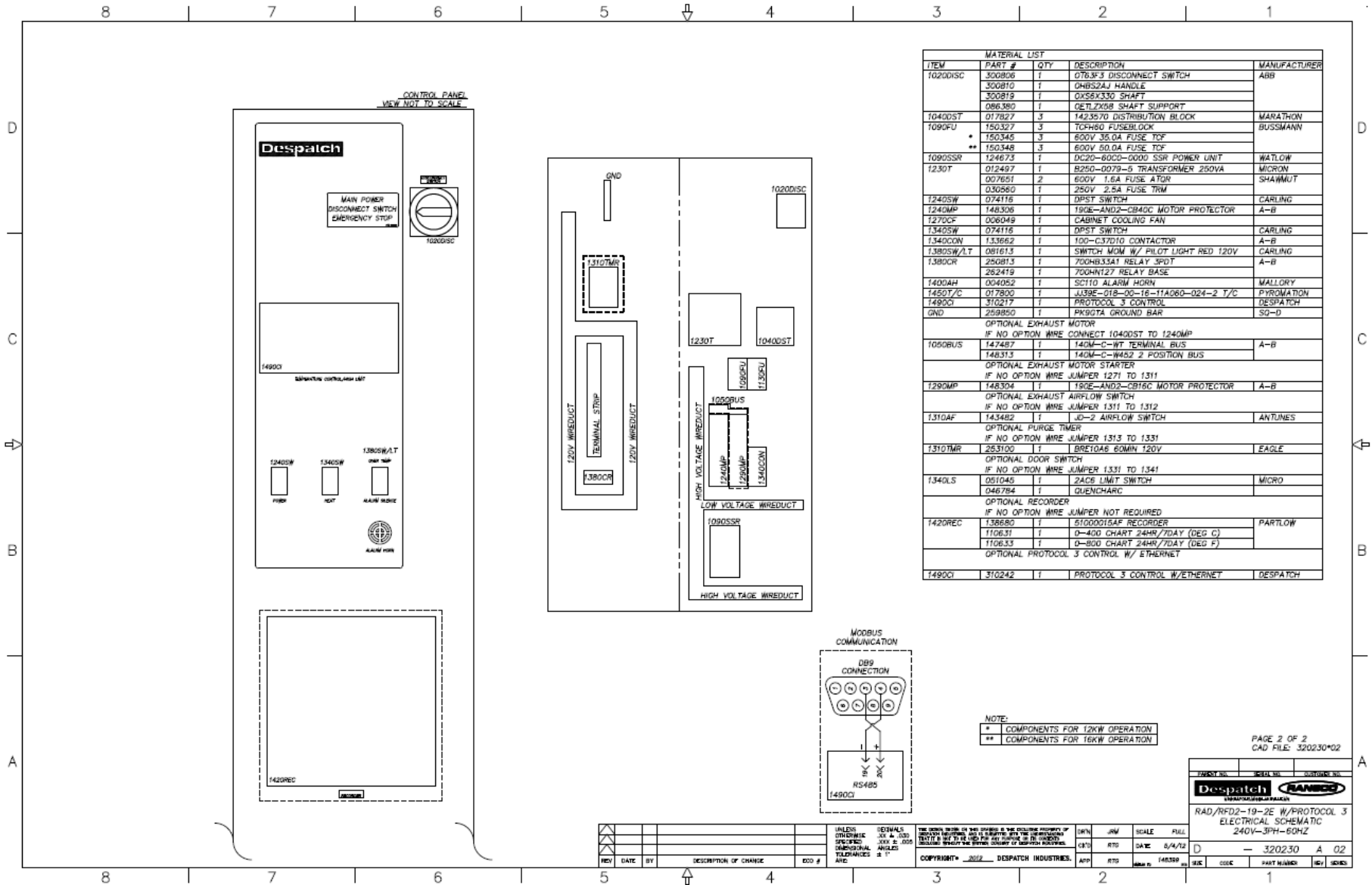

Figure 27. RFD2-19-2E, 240V (Drawing 320230-02).

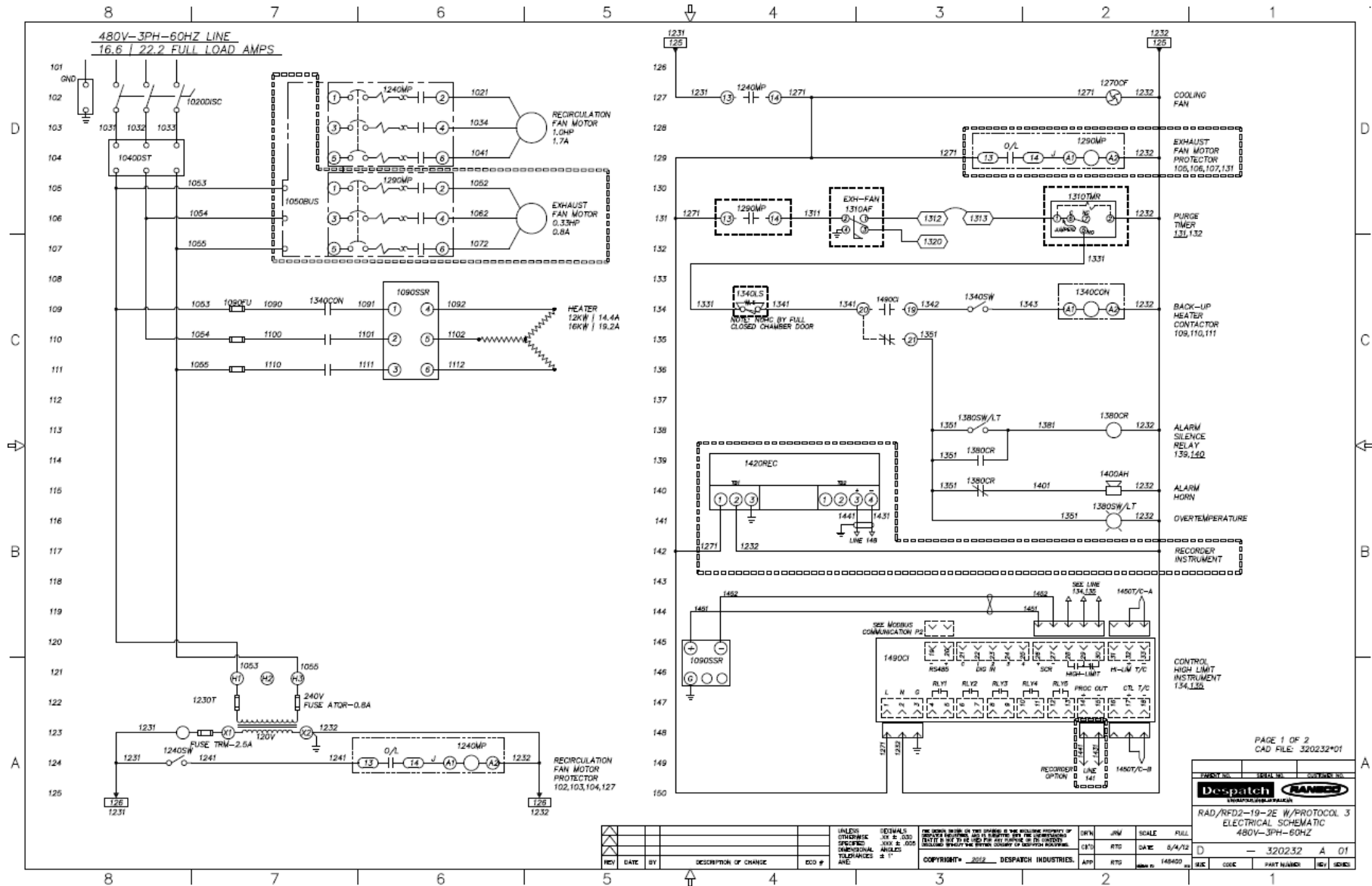

Figure 28. RFD2-19-2E, 480V (Drawing 320232-01).

Copyright © 2012 by Despatch Industries.

All rights reserved. No part of the contents of this manual may be reproduced, copied or transmitted in any form or by any means including graphic, electronic, or mechanical methods or photocopying, recording, or information storage and retrieval systems without the written permission of Despatch Industries, unless for purchaser's personal use.

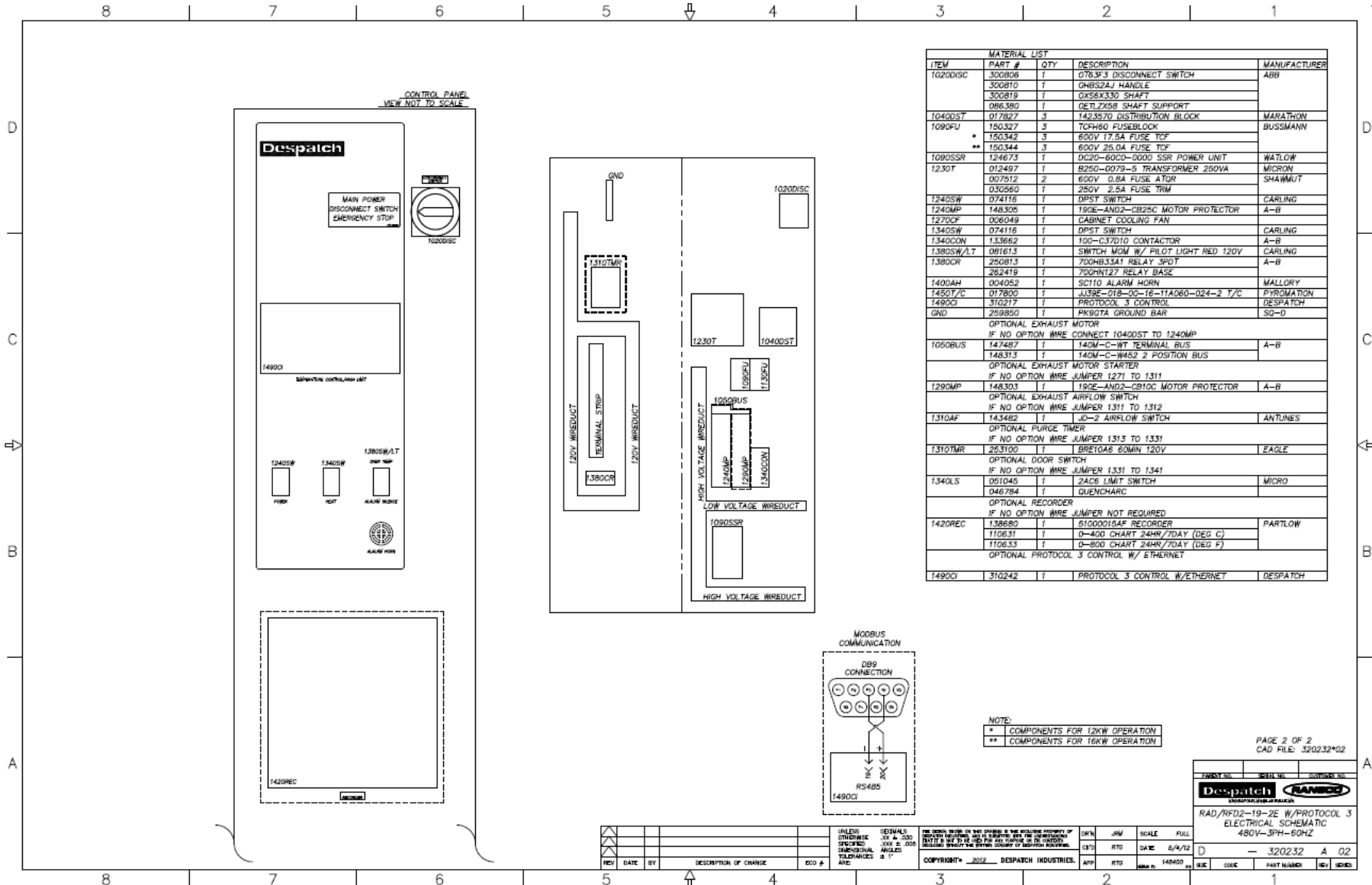

Figure 29. RFD2-19-2E, 480V (Drawing 320232-02).

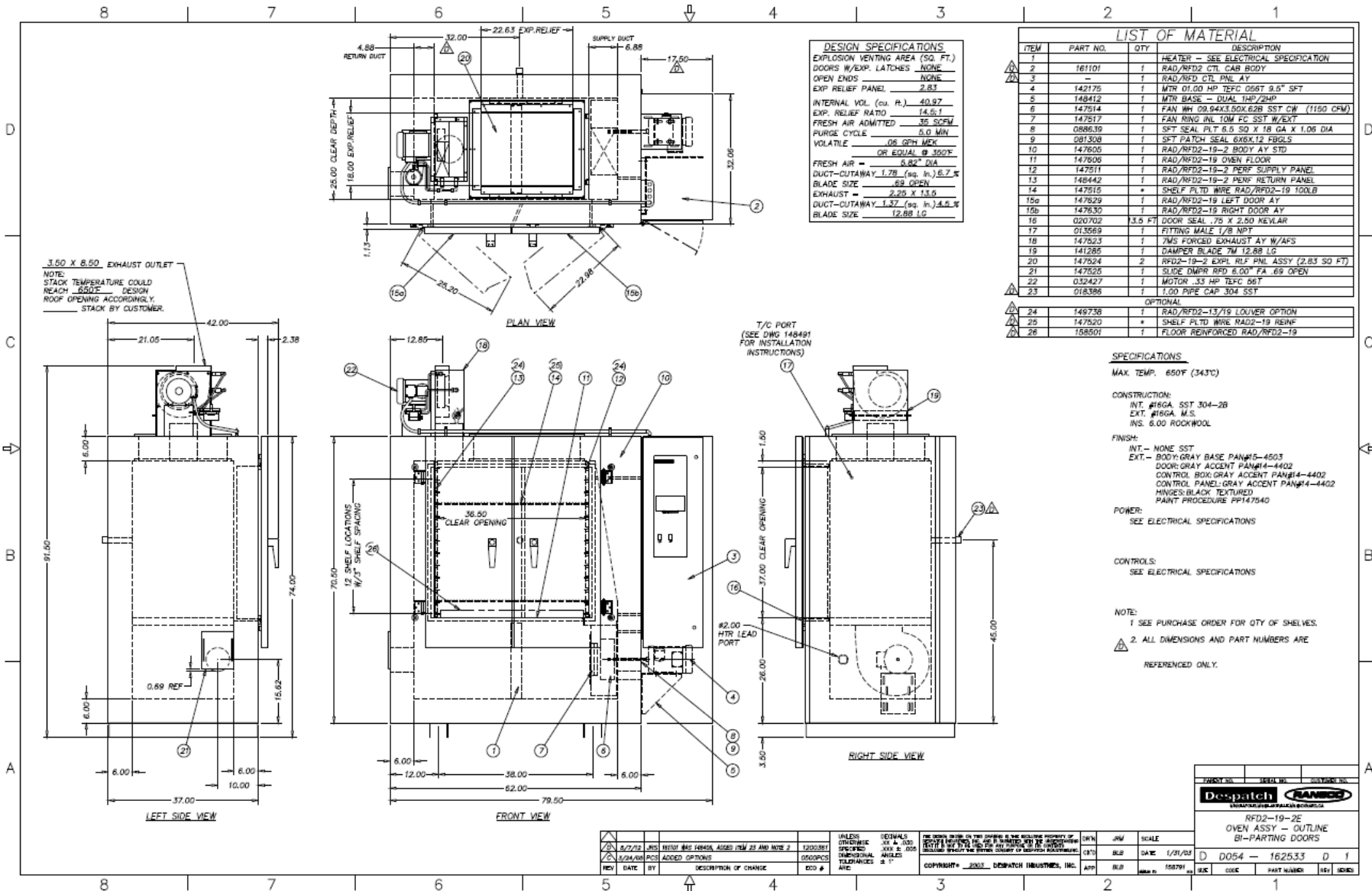

Figure 30. RAD2-19-2E Oven Assembly (Drawing 162533-01).

Copyright © 2012 by Despatch Industries.

All rights reserved. No part of the contents of this manual may be reproduced, copied or transmitted in any form or by any means including graphic, electronic, or mechanical methods or photocopying, recording, or information storage and retrieval systems without the written permission of Despatch Industries, unless for purchaser's personal use.

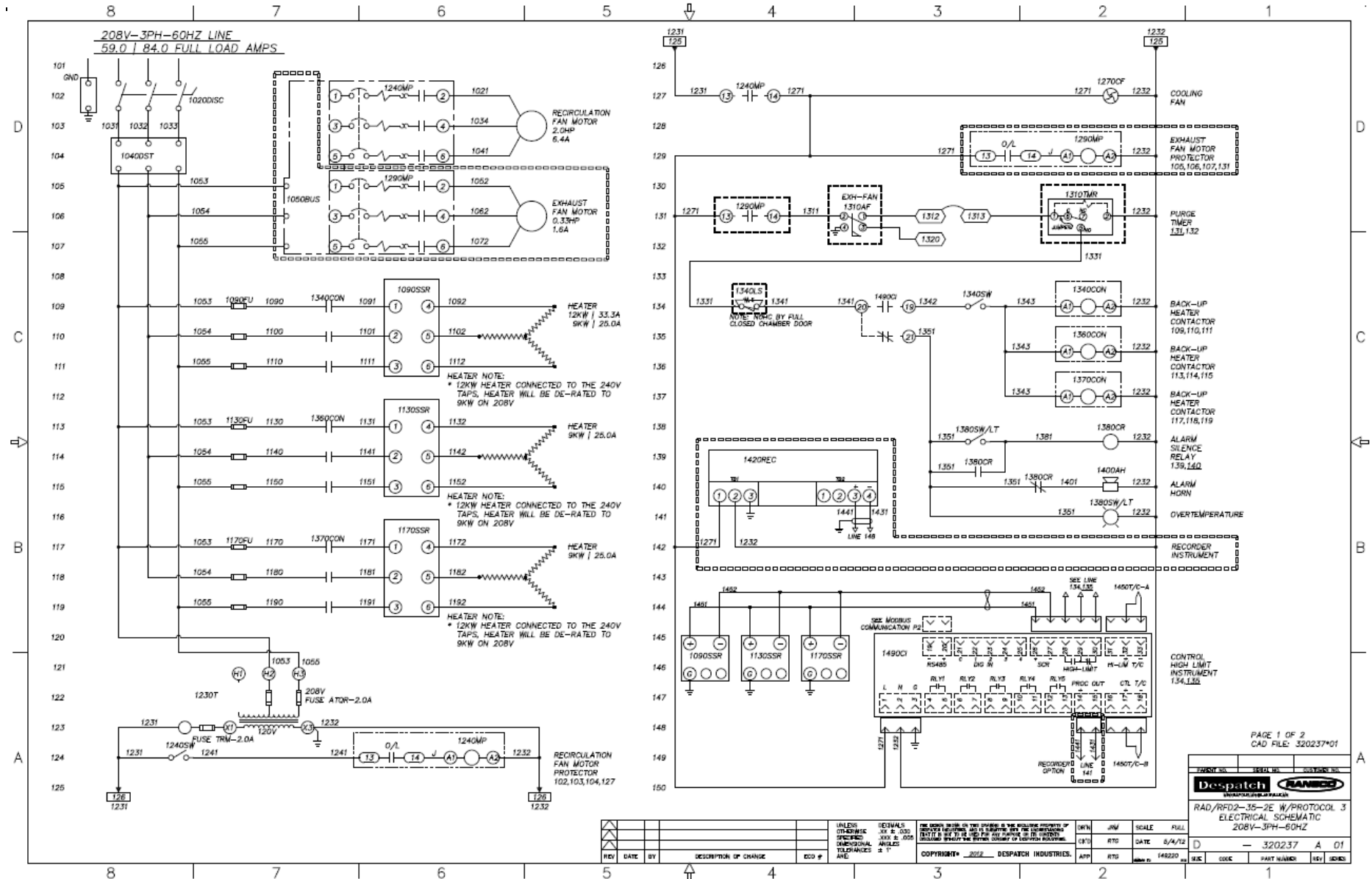

Figure 31. RFD2-35-2E, 208V (Drawing 320237-01).

Copyright © 2012 by Despatch Industries.

All rights reserved. No part of the contents of this manual may be reproduced, copied or transmitted in any form or by any means including graphic, electronic, or mechanical methods or photocopying, recording, or information storage and retrieval systems without the written permission of Despatch Industries, unless for purchaser's personal use.

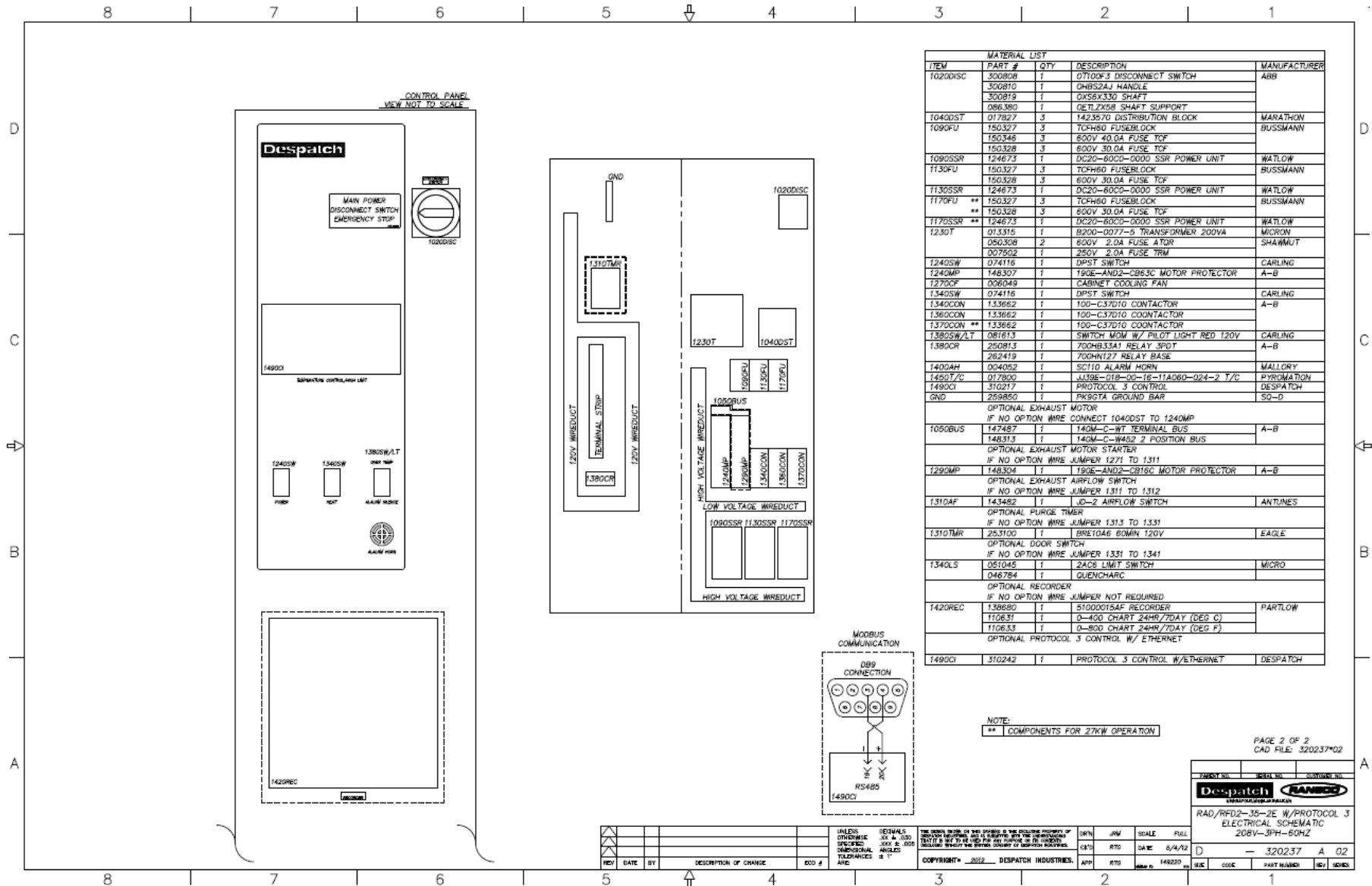

Figure 32. RFD2-35-2E. 208V (Drawing 320237-02).

Copyright © 2012 by Despatch Industries.

All rights reserved. No part of the contents of this manual may be reproduced, copied or transmitted in any form or by any means including graphic, electronic, or mechanical methods or photocopying, recording, or information storage and retrieval systems without the written permission of Despatch Industries, unless for purchaser's personal use.

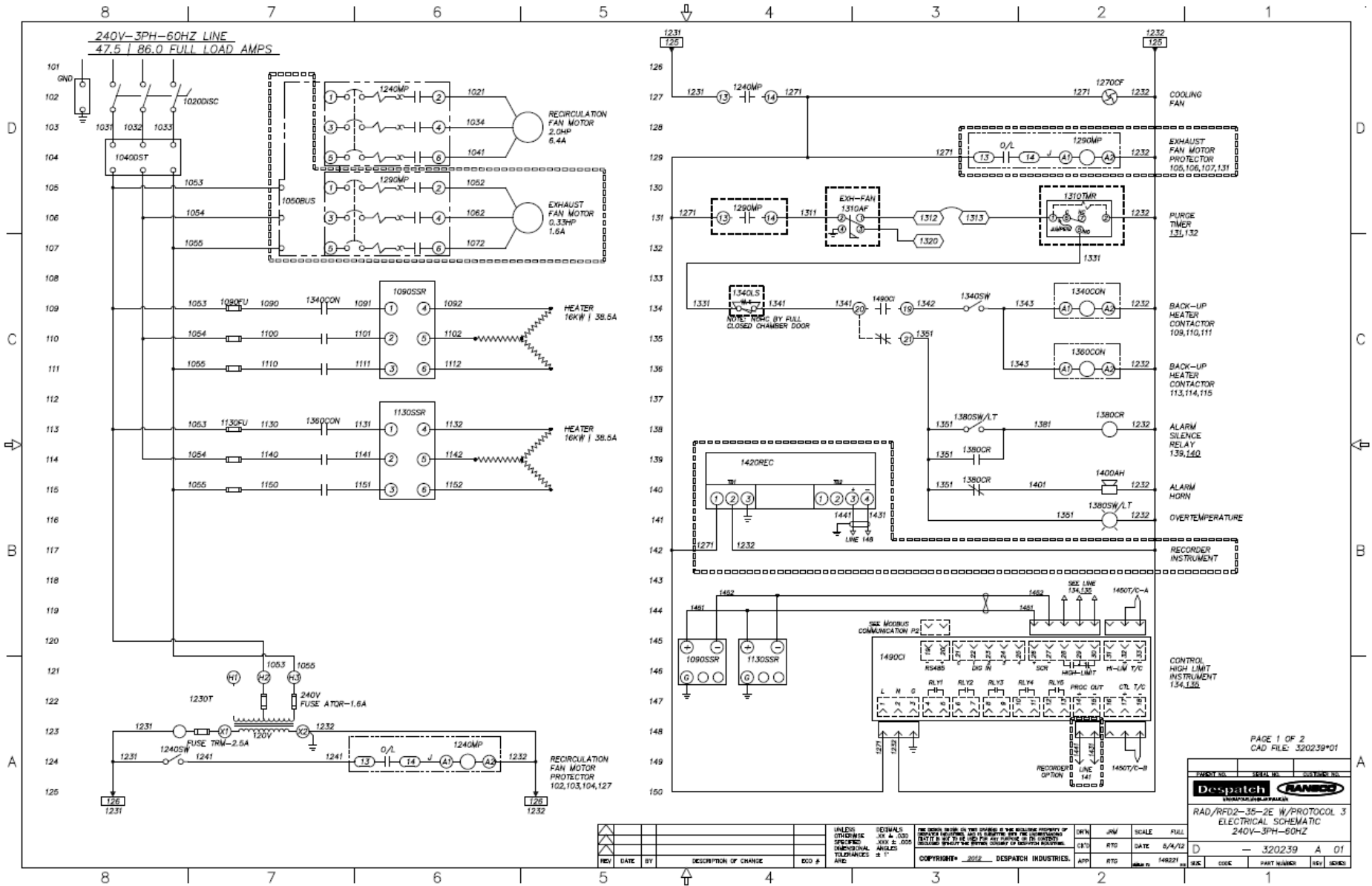

Figure 33. RFD2-35-2E, 240V (Drawing 320239-01).

Copyright © 2012 by Despatch Industries.

All rights reserved. No part of the contents of this manual may be reproduced, copied or transmitted in any form or by any means including graphic, electronic, or mechanical methods or photocopying, recording, or information storage and retrieval systems without the written permission of Despatch Industries, unless for purchaser's personal use.

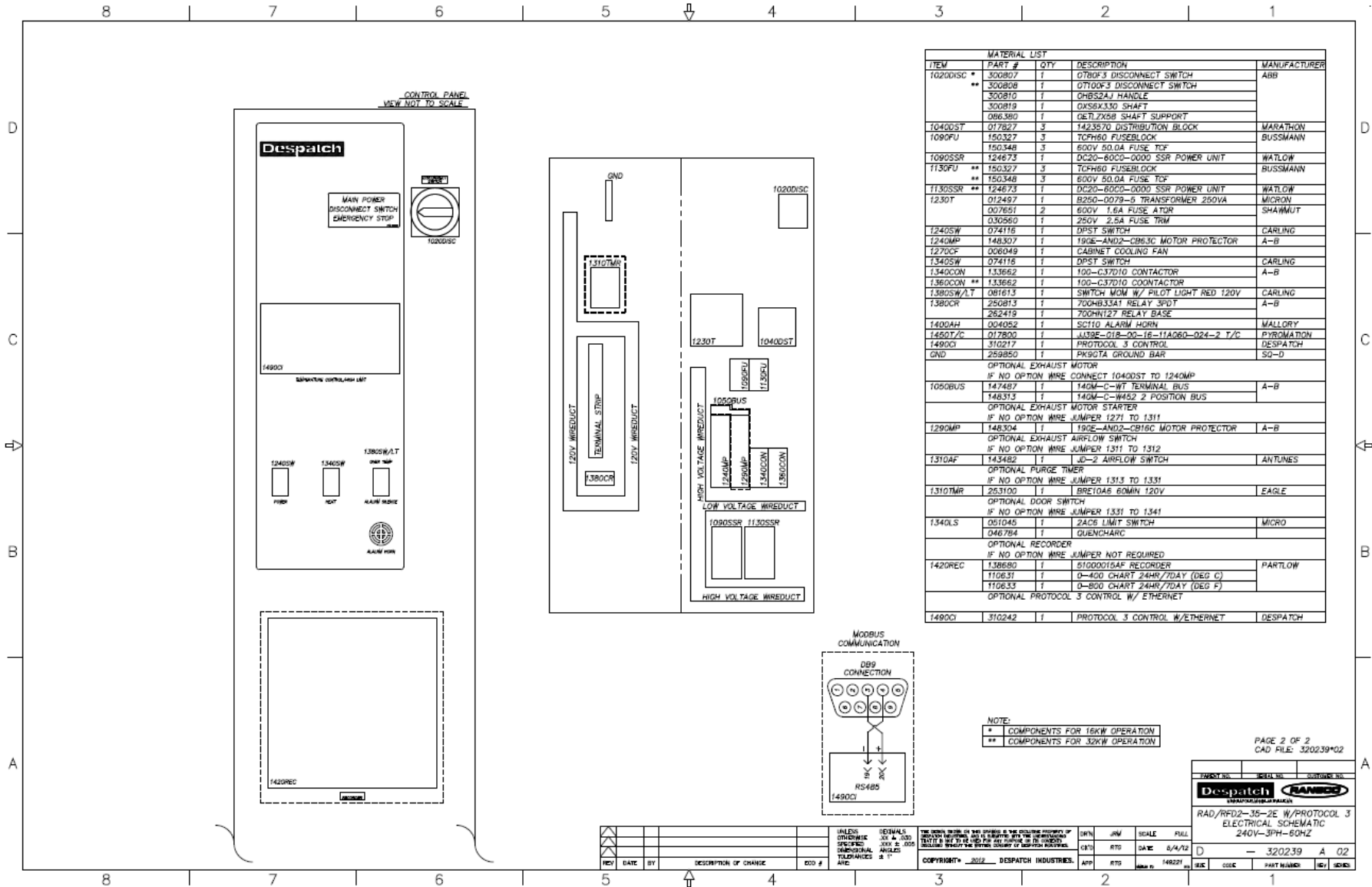

Figure 34. RFD2-35-2E, 240V (Drawing 320239-02).

Copyright © 2012 by Despatch Industries.

All rights reserved. No part of the contents of this manual may be reproduced, copied or transmitted in any form or by any means including graphic, electronic, or mechanical methods or photocopying, recording, or information storage and retrieval systems without the written permission of Despatch Industries, unless for purchaser's personal use.

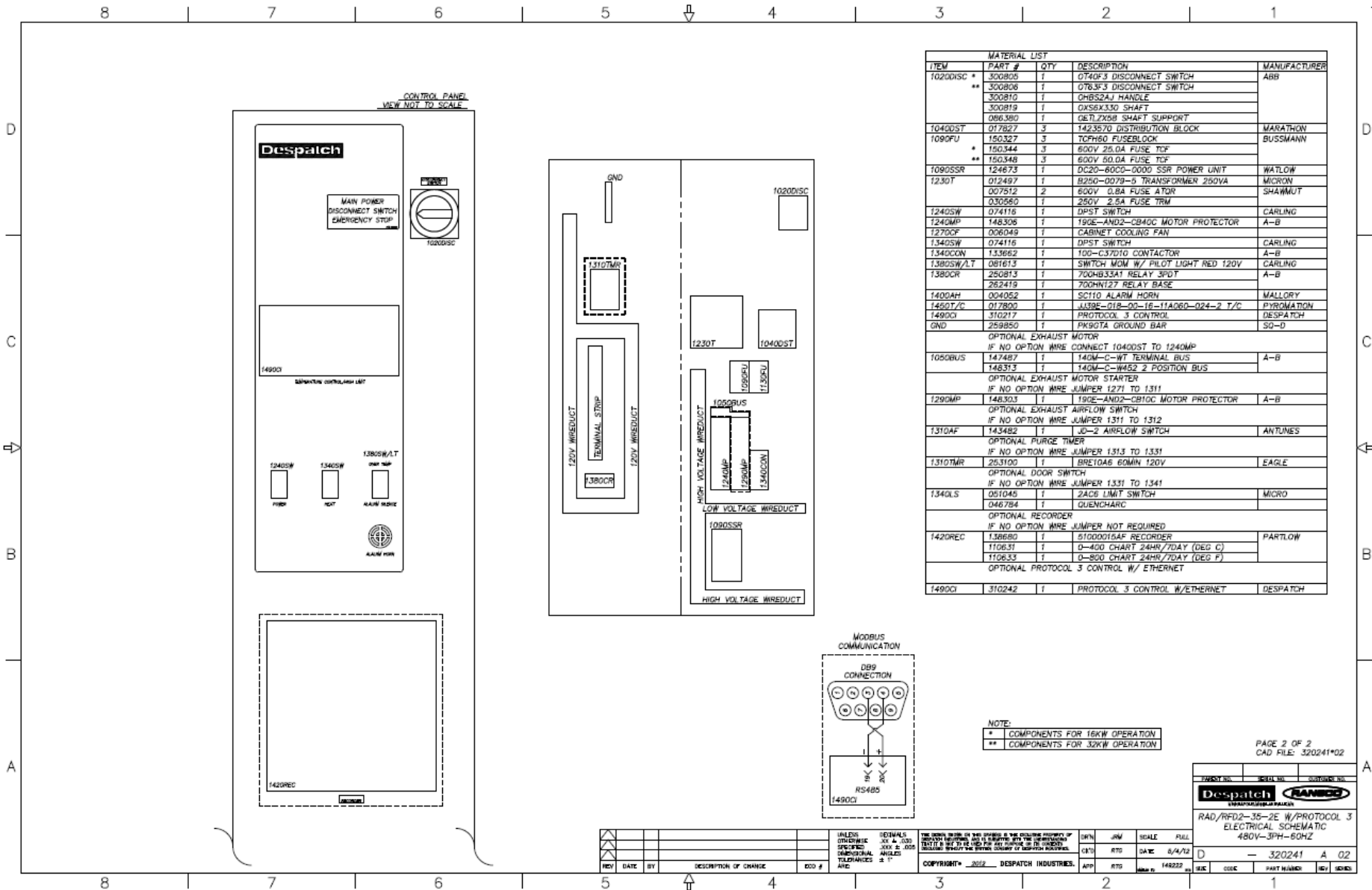

Figure 36. RFD2-35-2E, 480V (Drawing 320241-02).

Copyright © 2012 by Despatch Industries.

All rights reserved. No part of the contents of this manual may be reproduced, copied or transmitted in any form or by any means including graphic, electronic, or mechanical methods or photocopying, recording, or information storage and retrieval systems without the written permission of Despatch Industries, unless for purchaser's personal use.

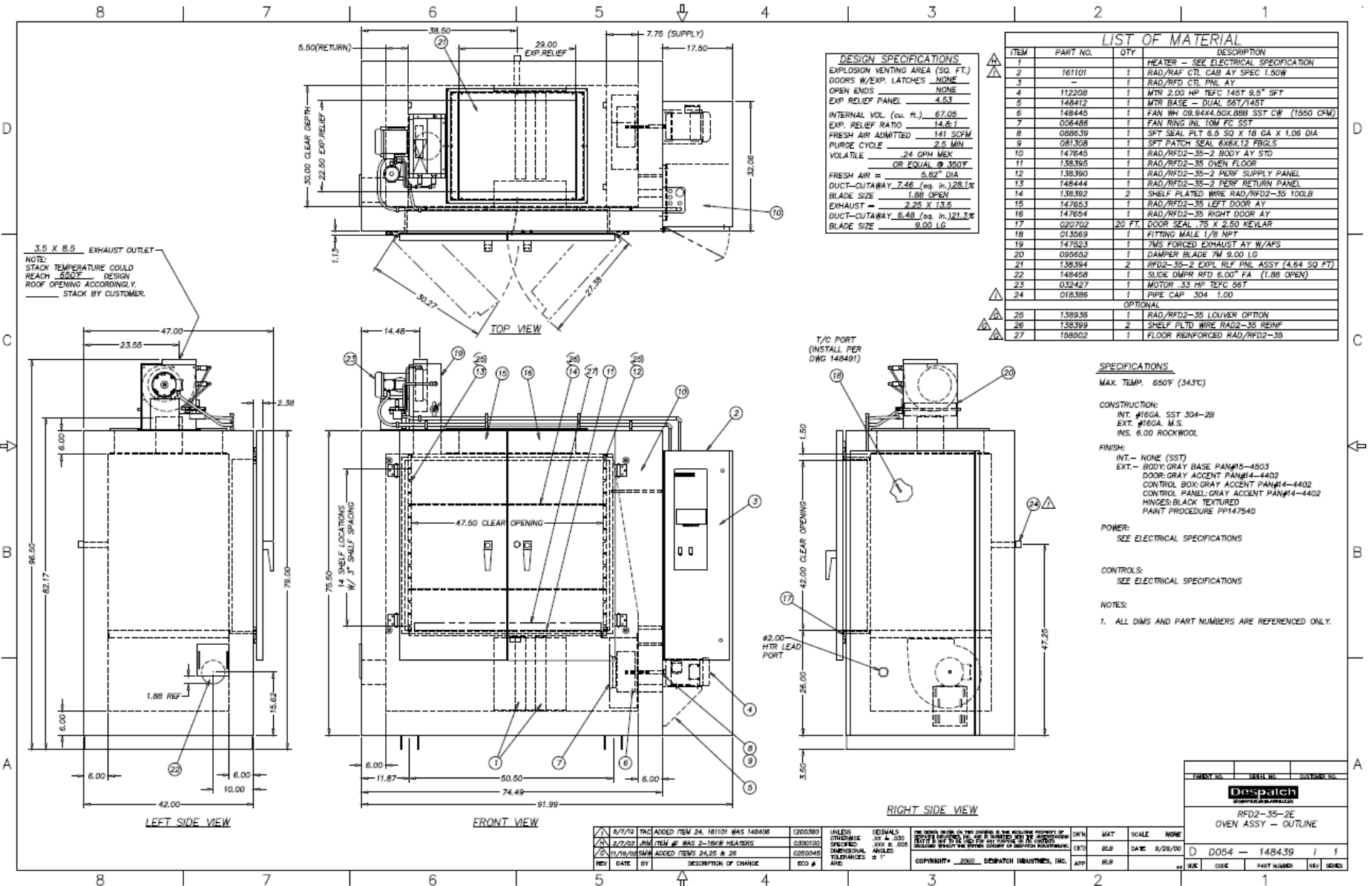

Figure 37. RFD2-35-2E Oven Assembly (Drawing 148439-01).

Copyright © 2012 by Despatch Industries.

All rights reserved. No part of the contents of this manual may be reproduced, copied or transmitted in any form or by any means including graphic, electronic, or mechanical methods or photocopying, recording, or information storage and retrieval systems without the written permission of Despatch Industries, unless for purchaser's personal use.

SERVICE AND TECHNICAL SUPPORT

Service parts: 1-800-473-7373

International service/main: 1-952-469-8230

Service fax: 1-952-469-8193

service@despatch.com

GLOBAL OFFICES

Germany: +49 30 629 073 410 / europe@despatch.com

China: +86-21-62365868 / shanghai@despatch.com

Taiwan: +886-3-6588484 / taiwan@despatch.com

USA HEADQUARTERS

Phone: 1-952-469-5424

US toll free: 1-888-337-7282

Fax: 1-952-469-4513

info@despatch.com

service@despatch.com

www.despatch.com

8860 207th Street West

Minneapolis, MN 55044 USA

Despatch
INDUSTRIES

© 2012 Despatch Industries. All rights reserved. Despatch is a registered trademark of Despatch Industries in the U.S. and other countries. No part of the contents of this manual may be reproduced, copied or transmitted in any form or by any means without the written permission of Despatch Industries, unless for purchaser's personal use.